

Operation Manual

Professional Power Amplifier
DSA-500Q/2000Q



interM

Welcome

A personal welcome to you from the management and employees of Inter-M

All of the co-workers here at Inter-M are dedicated to providing excellent products with inherently good value, and we are delighted you have purchased one of our products.

We sincerely trust this product will provide years of satisfactory service, but if anything is not to your complete satisfaction, we will endeavor to make things right.

Welcome to Inter-M, and thank you for becoming part of our worldwide extended family!



WARNING

To prevent fire or shock hazard, do not expose the unit to rain or moisture.



This symbol is intended to alert the user to the presence of uninsulated “dangerous voltage” within the product’s enclosure that may be of sufficient magnitude to constitute a risk of electric shock to persons.



This symbol is intended to alert the user to the presence of important operation and maintenance (servicing) instructions in the literature accompanying the appliance.

Caution: To prevent electric shock do not use this (polarized) plug with an extension cord, receptacle or other outlet unless the blades can be fully inserted to prevent blade exposure.

Attentions: Pour prévenir les chocs électriques ne pas utiliser cette fiche polarisée avec un prolongateur, une prise de courant on une autre sortie de courant, sauf si les lames peuvent être insérées à fond sans en laisser aucune partie à découvert.
Pour deconnecter complètement l'appareil du reseau d'alimentation. deconnecter le cordon d'alimentation de la prise murale.
La prise du reseau d'alimentation doit demeurer aisement accessible.

*WARNING FOR YOUR PROTECTION PLEASE READ THE FOLLOWING-WATER AND MOISTURE: Unit should not be used near water(e.g. near a bathtub, washbowl, kitchen sink, laundry tub, in a wet basement, or near a swimming pool, etc). Care should be taken so than objects do not fall and liquids are not spilled into the enclosure through openings.

*Do not install this equipment in a confined space such as a book case or similar unit.

*Warning : To reduce the risk of fire or electric shock, do not expose this apparatus to rain or moisture and objects filled with liquids, such as vases, should not be placed on this apparatus.

*This apparatus shall be connected to a mains socket outlet with a protective earthing connection.

*To completely disconnect this apparatus from the AC mains, disconnect the power supply cord plug from the AC receptacle.

*The mains plug of the power supply cord shall remain readily accessible.

CAUTION

*These servicing instructions are for use by qualified service personnel only. To reduce the risk of electric shock, do not perform any servicing other than that contained in the operating instructions unless you are qualified to do so.

NOTE

*This equipment has been tested and found to comply with the limits for a Class A digital device, pursuant to Part 15 of the FCC Rules. These limits are designed to provide reasonable protection against harmful interference when the equipment is operated in a commercial environment. This equipment generates, uses, and can radiate radio frequency energy and, if not installed and used in accordance with the instruction manual, may cause harmful interference to radio communications. Operation of this equipment in a residential area is likely to cause harmful interference in which case the user will be required to correct the interference at his own expense.

Contents

Unpacking	2
Installation	
Environment.....	2
Important Safety Instructions.....	2
Features	3
Contents and Accessories	3
Front Panel	4
Rear Panel	6
Installation Precautions	10
OLED Operating Instructions	11
Applications	23
Block Diagram	27
Specifications	28
Service	
Procedures.....	30
Schematic.....	30
Parts List	30
Variations and Options	30
Warranty	30

Unpacking

Although your DSA-500Q/2000Q is neither complicated nor difficult to operate, we recommend you take a few minutes to read this brief manual and familiarize yourself with the important information regarding product features, setup and operation.

As with most electronic devices, we strongly recommend you retain the original packaging. In the unlikely event the product must be returned for servicing, the original packaging (or reasonable equivalent) is required.

Installation

Environment

Never place this product in an environment which could alter its performance or reduce its service life. Such environments usually include high levels of heat, dust, moisture, and vibration.

IMPORTANT SAFETY INSTRUCTIONS

1. Read these instructions.
2. Keep these instructions.
3. Heed all warnings.
4. Follow all instructions.
5. Do not use this apparatus near water.
6. Clean only with dry cloth.
7. Do not block any ventilation openings. Install in accordance with the manufacturer's instructions.
8. Do not install near any heat sources such as radiators, heat registers, stoves, or other apparatus (including amplifiers) that produce heat.
9. Do not defeat the safety purpose of the polarized or grounding-type plug. A polarized plug has two blades with one wider than the other. A grounding type plug has two blades and a third grounding prong. The wide blade or the third prong are provided for your safety. If the provided plug does not fit into your outlet, consult an electrician for replacement of the obsolete outlet.
10. Protect the power cord from being walked on or pinched particularly at plugs, convenience receptacles, and the point where they exit from the apparatus.
11. Only use attachments/accessories specified by the manufacturer.
12. Use only with the cart, stand, tripod, bracket, or table specified by the manufacturer, or sold with the apparatus. When a cart is used, use caution when moving the cart/apparatus combination to avoid injury from tip-over.
13. Unplug this apparatus during lightning storms or when unused for long periods of time.
14. Refer all servicing to qualified service personnel. Servicing is required when the apparatus has been damaged in any way, such as power-supply cord or plug is damaged, liquid has been spilled or objects have fallen into the apparatus, the apparatus has been exposed to rain or moisture, does not operate normally, or has been dropped.



Features

- HIGH-POWERED, HIGH-CAPACITY 4-CHANNEL CLASS-D POWER AMPLIFIER

Features a high-powered, high-capacity Class-D Power Amplifier capable of producing up to 3200W (800WX4CH)/8000W (2000WX4CH).

* DSA-500Q-4Ω: 500W-4CH, 2Ω: 800W-4CH

* DSA-2000Q-4Ω: 2000W-4CH, 2Ω: 2000W-4CH

- DANTE AUDIO NETWORK TRANSMISSION SOLUTION

The device features the DANTE Audio Network Transmission Solution from Audinate which enables audio transmissions via a TCP/IP Ethernet Network.

- BUILT-IN HIGH-PERFORMANCE DSP ENGINE

The device features a built-in high-performance Digital Signal Processor (DSP) that controls Digital Audio.

- REMOTE-CONTROL CONTROL FUNCTION

You can use network ports to remote-control the device from a PC program.

- OLED SCREEN AT THE FRONT

The device features an OLED panel at the front which allows you to configure all settings without connecting to a PC.

- SIMPLE CLEANING INSTRUCTIONS FOR THE DUST FILTER

You can simply loosen the screws on the front panel to remove dust from the filter.

- PERFECT PROTECTION CIRCUIT

The protection circuit fully protects the device against overheating amps, power shortages, overloads, power-related malfunctions, and DC output.

- SWITCH MODE POWER SUPPLY (SMPS) TECHNOLOGY

The device uses highly efficient, light weight SMPS technology.

- POWERFUL SOUND QUALITY AND DELICATE SOUND CONTROL

With a high S/N ratio and low THD, the device delivers powerful sound quality and delicate sound control.

- STATUS-INDICATING LEDS

Power, PRT, -10, -30, BRG LEDs indicate the status of the device.

- XLR ANALOG AUDIO INPUT/LINK

The device features male and female XLR cable input terminals which makes it easier to connect with other equipment e.g. Input Link.

Contents and Accessories

1. AC power con x 1EA
2. User manual x 1EA

Front Panel

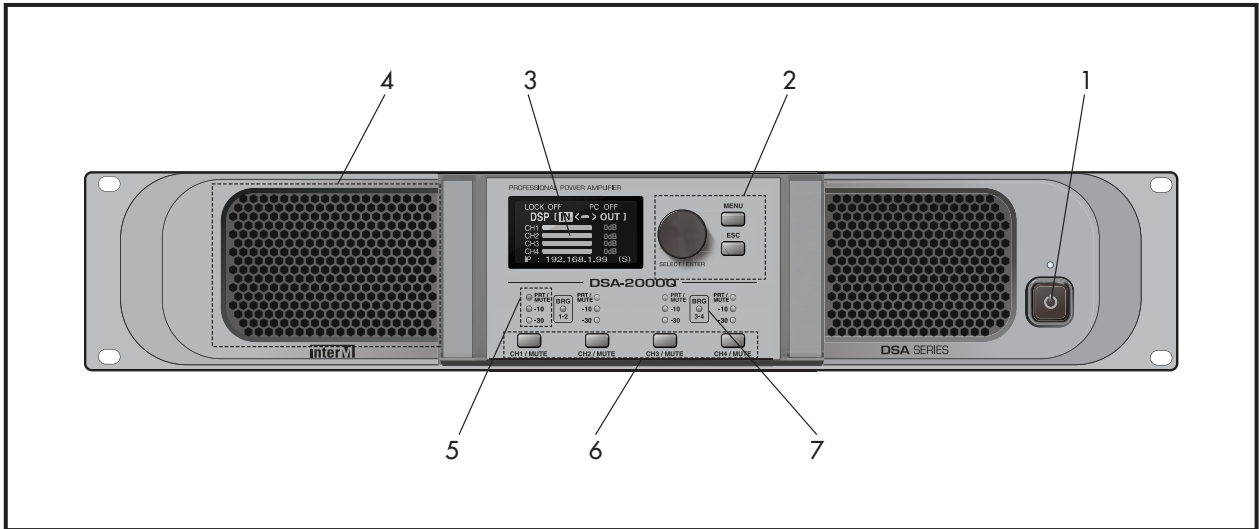

1. POWER SWITCH, POWER LED

Switch that supplies power to the system. If you connect the power cable to the AC Input at the back, then press the switch, power will be supplied to the device and the power LED (blue) will come on.

2. SELECT/ENTER(ENCODER), MENU, ESC

You can turn the SELECT/ENTER (ENCODER) left/right to control the volume and navigate the menu. You can use the MENU and ECS to configure all settings without connecting to a PC.

3. OLED

OLED that displays the status and MODE settings of the device.

※ Please be aware that the device may malfunction and the OLED screen may suffer from low resolutions if used in a humid location.

4. AIR VENTS

Air circulation vents to prevent the device from overheating. Please be careful not to block the front/back of the vents.

5. PRT (PROTECT)/MUTE INDICATOR AND LEVEL INDICATOR (CH1, CH2, CH3, CH4)

1) The PRT/MUTE indicator indicates that the device is currently not producing sound. It comes on/off regardless of the device's connection status. If the indicator comes on, you can check if the device's status is at PRT or MUTE from the OLED panel at the front of the PC program.

- If the PRT indicator is on:

The PRT indicator comes on if power is not being supplied to the device correctly, or a problem has occurred with the wire connections/speaker connections, or each channel of the equipment has been overloaded. When the indicator comes on, remove all cables connected to the device, wait until the FAN stops moving (approximately 15 seconds), then restart the device in accordance with standard booting protocols.

If the device operates normally when power is connected, it is highly likely that an issue has occurred

with the speaker lines and/or connected cables. As such, check the status of XLR cables, etc. connected to the device, and reconnect if necessary. If the PRT/MUTE indicator remains when power is re-connected and the OLED panel at the front or the window program indicates PRT, it may mean the device is broken. In such case, inspect your device at the Inter-M branch you purchased your device or visit our customer service center.

- If the MUTE indicator is on:
Output has been turned OFF via the DSP of the device/ If you want to resume output, please release the MUTE function.

2) Indicator that shows the output level of this device.

-30: Green, -10: Green, PRT: Red

6. CH SELECT/MUTE BUTTON (CH1, CH2, CH3, CH4)

Button that enables you to select the corresponding channel. The device will select the corresponding channel if you press a button. The channel will be MUTED if you press the same button again.

7. BRG LED

LED that indicates the BRIDGED mode. If you set the device to the BRIDGED MODE, the BRG LED (orange) will come on.

Please refer to the instructions on page 13 of this manual for details on how to set up the BRIDGED MODE. In BRIDGED MODE, you can control the level for CH1-2 with the volume for CH1, and control the level for CH3-4 with the volume for CH3.

※ Caution: Output levels rise in BRIDGED MODE, so please make sure to check the output levels.

Rear Panel

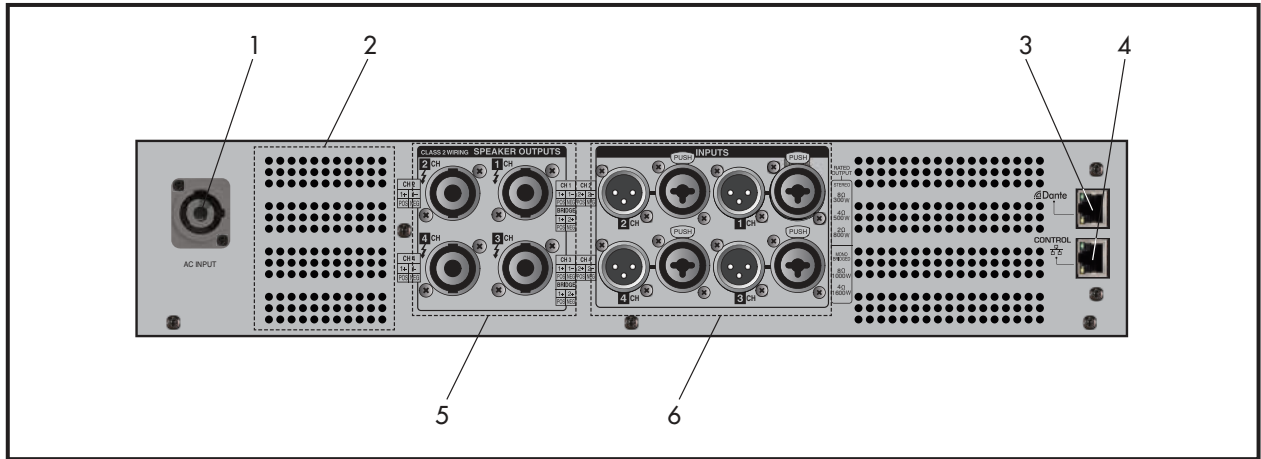

1. AC INPUT TERMINAL

Terminal that connects the power cord that comes with the device. The power source is AC 220-240V, 50/60Hz.

※ For DSA-500Q, the FAN will begin operating quickly when the AC Powercon that comes with the device is removed or the power supply is shut down. This is to lower the heat generated during the device's operation and discharge it to make the product set safe. If you want to move the set, please disconnect the AC Powercon or remove the power supplier, then wait until the FAN stops operating.

2. AIR VENTS

Air circulation vents to prevent the device from overheating. Please be careful not to block the front/back of the vents.

3. DANTE DIGITAL AUDIO PORT

A PORT that facilitates the audio transmission through the Dante network made by Audinate. You can use this PORT and network cables to receive and play audio.

4. ETHERNET PORT

A PORT that connects to ETHERNET through an RJ-45 jack. When selecting a cable, please choose a DIRECT cable. Please refer to the PC program manual for instructions on the PC program. You can download the PC program manual from our company's official website (www.inter-m.net). A network connector (RJ-45) that supports 100/1G Base-t.

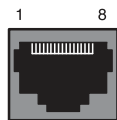

<100 Base-T>

<1G Base-T>

PIN NO	Function	PIN NO	Function
1	TXN	1	MX(0)+
2	TXP	2	MX(0)-
3	RXN	3	MX(1)+
4	NA	4	MX(1)-
5	NA	5	MX(2)+
6	RXP	6	MX(2)-
7	NA	7	MX(3)+
8	NA	8	MX(3)-

DSA-SERIES can be connecting using a CAT5E, CAT6 cable.

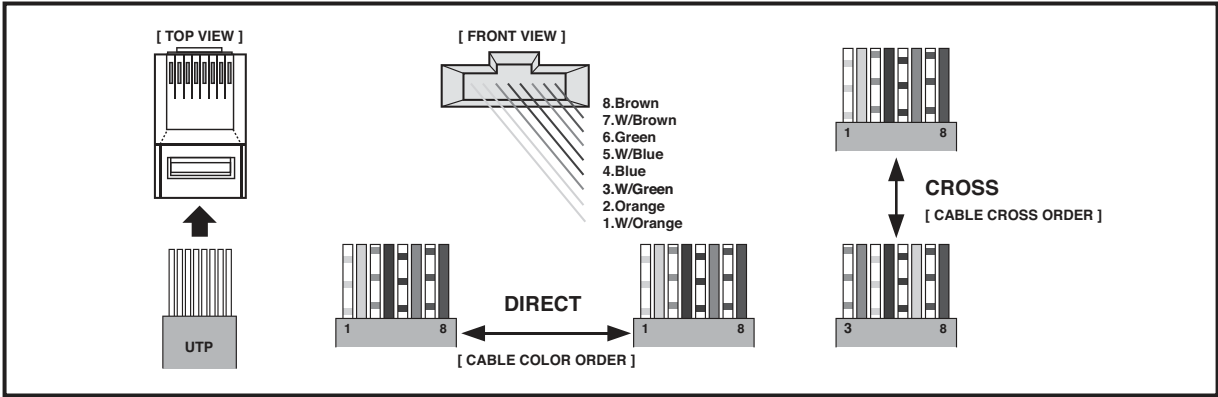

5. SPEAKER CONNECTION TERMINAL

The Speaker Connection Terminal features a 4 Pole Speaker Socket.

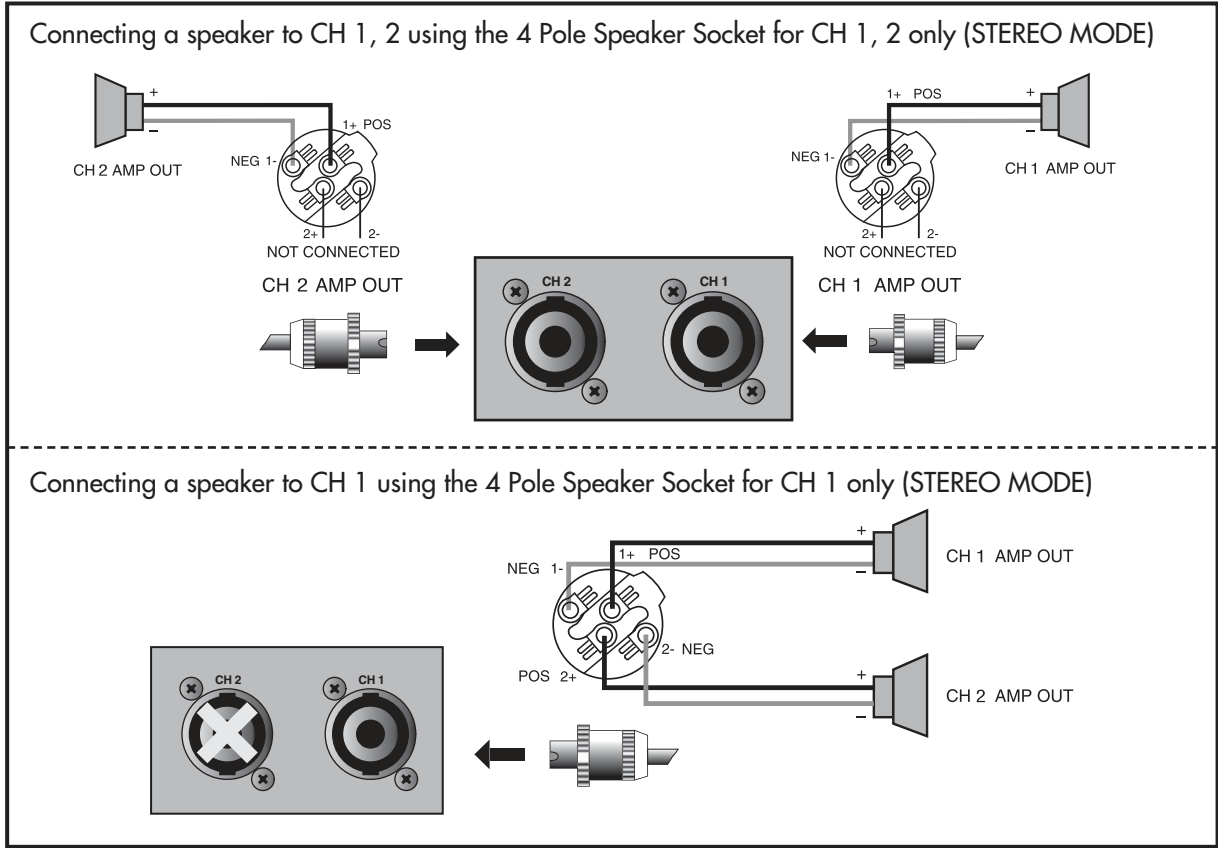

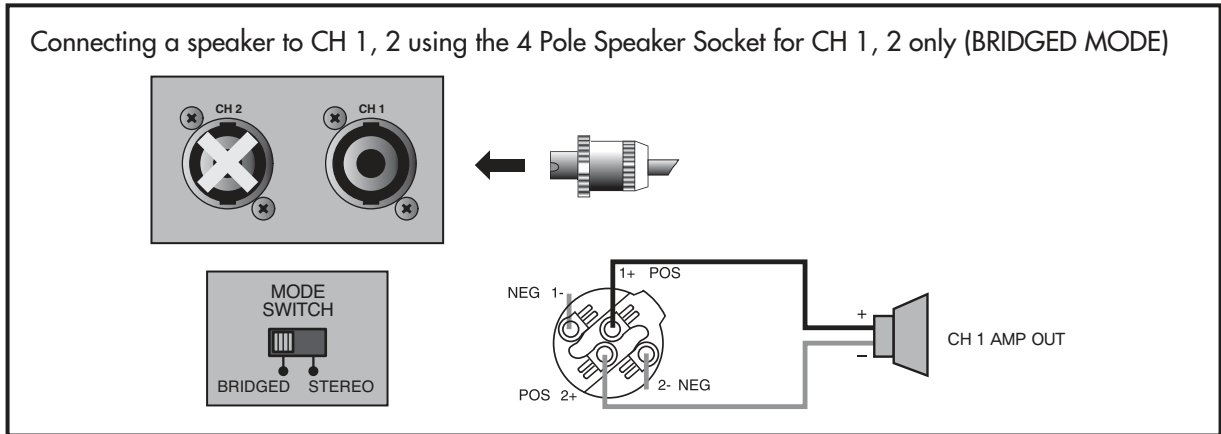

※ Caution: When installing the system, ensure that the total impedance of the speaker does not fall below the regulated impedance (4Ω , 8Ω) under all circumstances. Otherwise, it may lead to overloading and cause the system to fail.

STEREO MODE

The device produces the input signal from each channel independently. It produces the input signal from CH1 through CH1, and the input signal from CH2 through CH2. In STEREO mode, you can control the volume of each channel independently.

BRIDGED MODE

You can use this mode when you want to tie CH1 and CH2 together to produce a larger sound than you can in STEREO mode. If you connect the speaker in BRIDGED mode, as shown above, you can double the input signal of CH1.

※ Caution

1. In BRIDGED mode, please input through CH1 or CH3 only. The device can double the input signal through CH1 or CH3 only, therefore make sure not to use CH2 or CH4.
2. When you connect the speaker in BRIDGED mode, use PIN 1(+) and PIN 2(+) from the 4 Pole Speaker Connector for CH1 or CH3. (Please refer to the image above.)
3. Turn the volume for CH2 or CH4 all the way down, then control the volume for CH1 or CH3.
4. BRIDGED mode supports 4Ω , 8Ω only.

6. XLR INPUT/LINK Terminal

XLR INPUT TERMINAL

An Input Terminal used when connecting the output of a preamplifier or audio mixer to this device. It features an XLR (female) jack. When using the XLR Input Terminal, please use a balanced jack. If you use an unbalanced jack, it may have a significant impact on cable noise. Therefore, use unbalanced jacks only when devices are grouped closely together. If using a balanced jack in an unbalanced manner, please refer to the following image to connect.

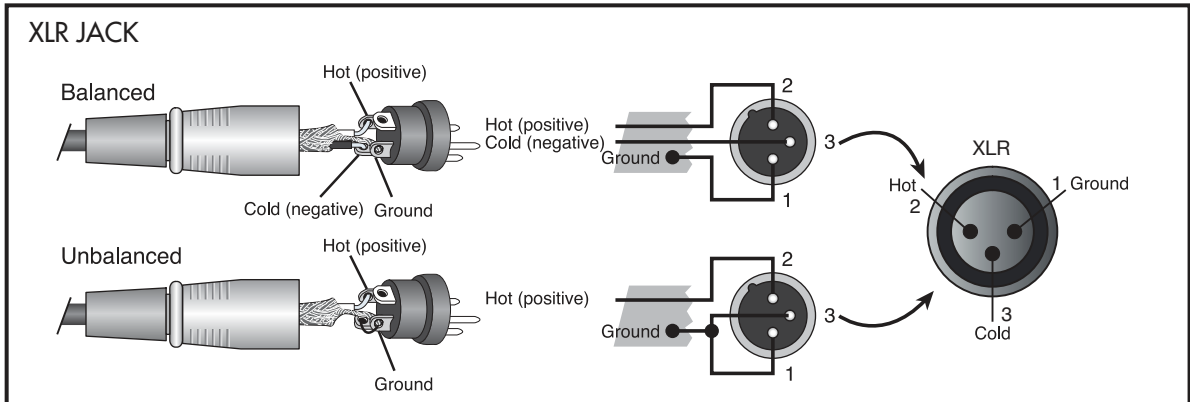

XLR LINK TERMINAL

Features an XLR (male) jack which enables you to link the signal from a particular channel with another amplifier, device, or channel. When using the XLR Link Terminal, please use a balanced jack. If you use an unbalanced jack, it may have a significant impact on cable noise. Therefore, use unbalanced jacks only when devices are grouped closely together. If using a balanced jack in an unbalanced manner, please refer to the following image to connect. The XLR Link Terminal is positioned alongside the XLR Input Terminal.

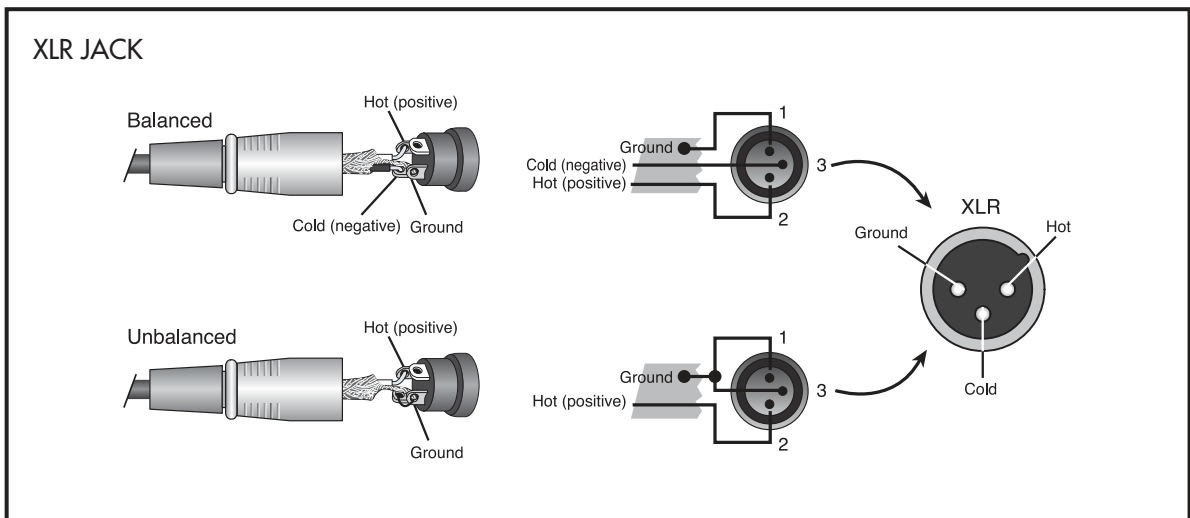

Installation Precautions

1. This unit employs front air intake, rear exhaust forced air cooling, therefore, when installing in portable rack, leave the rear opening clear of obstructions.

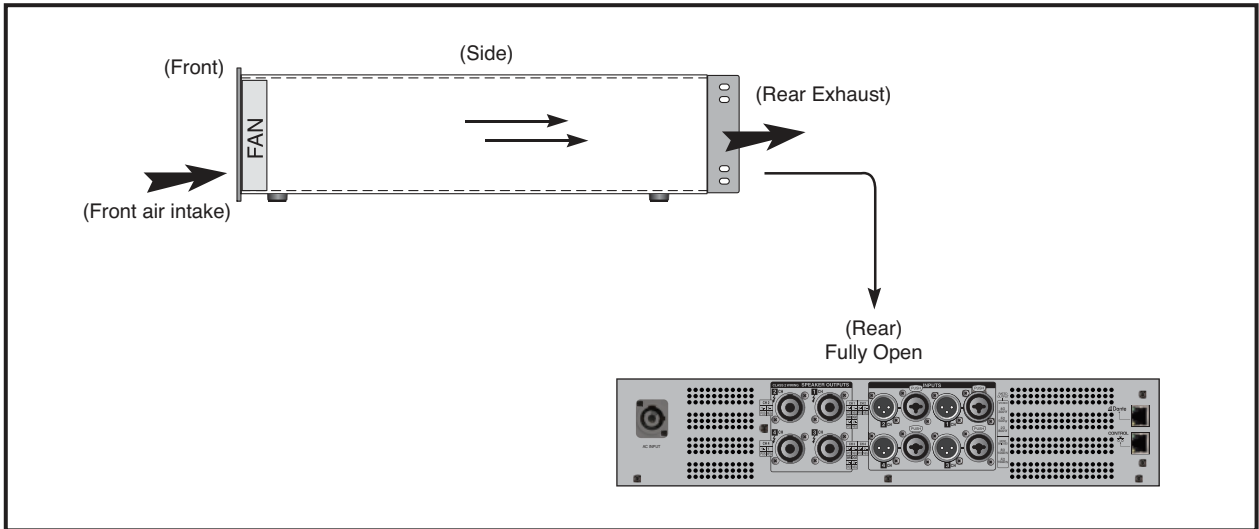

2. When using power amplifier, please install the unit where there is no airflow block to the heat sink.

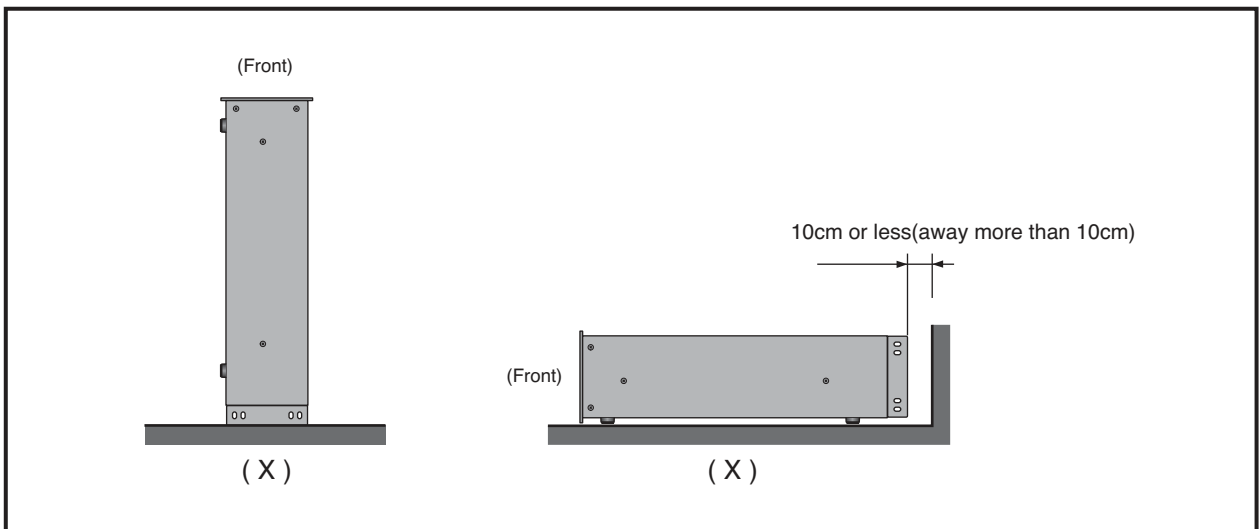

OLED Operating Instructions

1. Initial screen when you turn the power ON

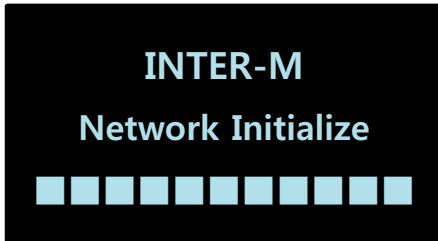

This initial screen appears when the power cable is connected to the set and the DSP begins to boot up. It indicates that the device is currently booting up. Boot-time is approximately 10 seconds.

2. Switch OFF screen once booting is complete.



This screen indicates that the power cable has been connected and the power switch remains OFF, but the device has completed its boot-up protocol. If you turn the switch ON when the system is displaying this screen, power will be supplied and the OLED control screen will appear.

3. Initial OLED Control Screen

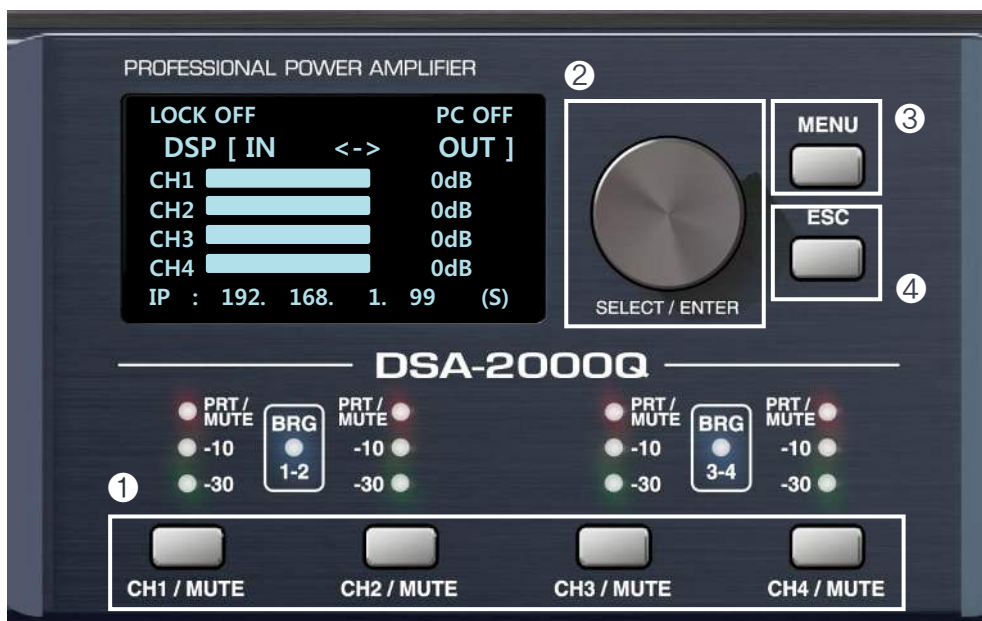

The above screen appears once the power is connected, booting is complete, and the power switch has been turned ON. It displays the volume and IP address for each channel, and you can check the connection status of your PC.

- Initial Settings

- Volume of each channel: You can control between -50.0dB and 00.0dB

- IP Address: 192.168.1.99

- Description of Button Functions

- ① CH/MUTE BUTTON: Switches the OLED panel from the initial screen to the Volume Set screen where you can control the volume of a particular CH.
- ② SELECT/ENTER(ENCODER): If you rotate the dial left/right, you can scroll up/down or left/right and change the values on the screen. If you press the dial down, you can select the corresponding function. The system will redirect you to the sub-level.
- ③ MENU BUTTON: Switches the OLED panel from the initial screen to the Menu screen where you can configure the settings.
- ④ ESC BUTTON: The screen goes back to its previous state.

※ Precautions

TEMP LIMIT

If the temperature of the device exceeds 50°C, the system immediately operates the FAN. If the temperature of the device exceeds 70°C, the system goes into TEMP LIMIT mode and reduces its output level to 1/16W. You can check the TEMP LIMIT status from the OLED panel at the front or the PC program.

Once the device goes into TEMP LIMIT mode, reduce the input level, check whether the FAN inside the device is operational, and inspect the air vents to cool the device down sufficiently. Please be aware that if the temperature of the device continues to rise, the device will go into PRT status and power itself down. The device manages its TEMP LIMIT status separately for different CH groups i.e. it separates the CH1/2 group from the CH3/4 group.

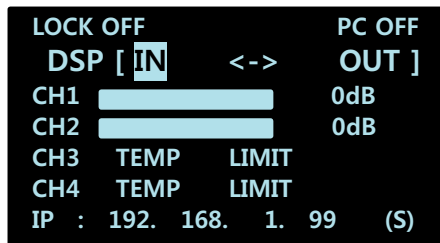

OUTPUT SHORT

When a malfunction occurs to the device due to an output speaker wire short, a speaker connection error (connected at 2Ω or below), or an overload in 2Ω/4Ω BRIDGE mode, the system goes into OUTPUT SHORT mode. You can check the OUTPUT SHORT status from the OLED panel at the front or the PC program.

In OUTPUT SHORT mode, the device will not produce sound unless power is turned ON/OFF using the power switch at the front or the AC Powercon.. (LATCH protection circuit activated) Once the device goes into OUTPUT SHORT mode, check the input level of the device, the speaker connection (check speaker impedance), and the speaker cable connection (whether or not a short has occurred). Unlike TEMP LIMIT, the device manages its OUTPUT SHORT status separately for each CH.

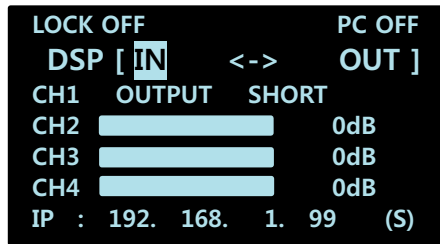

3. 1 CHANNEL GAIN/MUTE SETTING



You will be redirected to this screen if you press the CH/MUTE button from the initial OLED screen.

You can turn the SELECT/ENTER (ENCODER) dial left/right to control the volume.

If you press the CH/MUTE button again after selecting a channel, you can use the MUTE function for the corresponding channel. If you press the button again in MUTE, you can return the system to its original sound level.

You will be redirected to the previous screen when you press the ESC button.

3. 2 MENU/FUNCTION SELECTION

You can select the INPUT/OUTPUT MENU if you turn the SELECT/ENTER (ENCODER) dial left/right from the initial OLED screen.

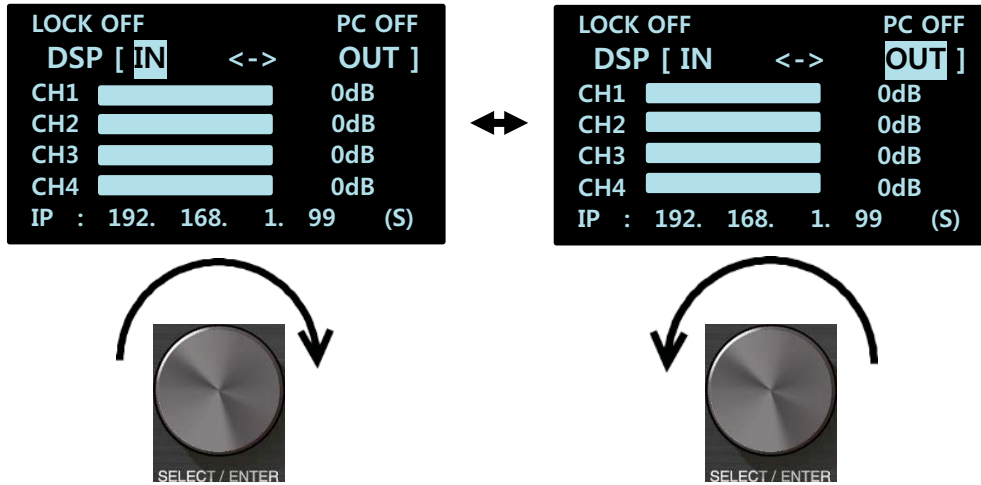

If you press down the SELECT/ENTER (ENCODER) dial after navigating to the item you want to adjust, you will be redirected to the sub-settings of the particular item. You can adjust the GAIN for each channel between -50.0dB and 00.0dB. You can change the integer and the decimal points separately. Also, the integer and decimal points that can be adjusted will be highlighted with a white background as shown in the above image.

- IN MENU

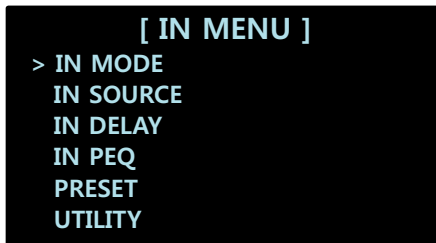

The IN MENU features multiple items including IN MODE, IN SOURCE, IN DELAY, IN PEQ as well as PRESET and UTILITY. PRESET, UTILITY items are also available in the OUT MENU.

- OUT MENU

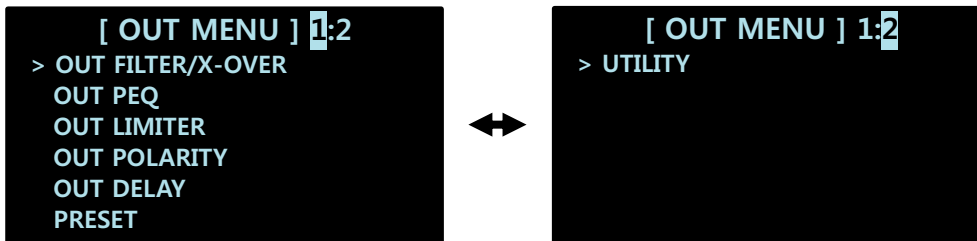

The OUT MENU features multiple items including OUT FILTER/X-OVER, OUT PEQ, OUT LIMITER, OUT POLARITY, OUT DELAY as well as PRESET and UTILITY. PRESET, UTILITY items are also available in the IN MENU.

4. IN MENU

4. 1 MODE SETTING

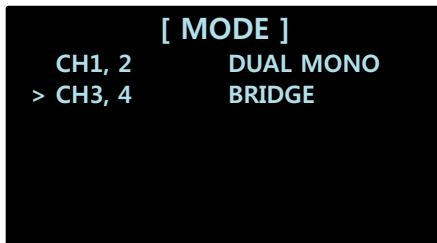

In MODE settings, you can select 5 different modes: DUAL MONO, STEREO, BI-AMP 1, BI-AMP 2, and BRIDGE. Initially, CH1, 2, 3, 4 are all set to DUAL MONO.

If you select BRIDGE MODE, the BRG LED at the front comes on (orange).



4. 2 SOURCE SETTING

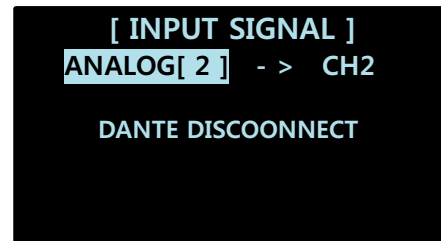
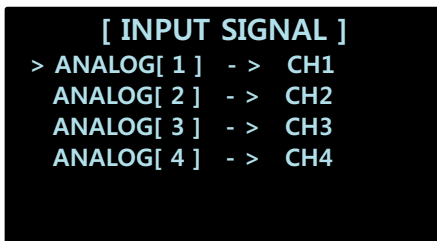

In SOURCE settings, you can distribute the audio signal received through the XLR INPUT/LINK terminal at the back of the device or through the network and the DANTE Digital Audio PORT to the output channel (speaker connection terminal) you want to use. Initial configuration: ANALOG[1]->CH1, ANALOG[2]->CH2, ANALOG[3]->CH3, ANALOG[4]->CH4. You can select from 8 SOURCES, including ANALOG [1]~[4], DANTE [RX0]~[RX3], etc.

4. 3 DELAY SETTING

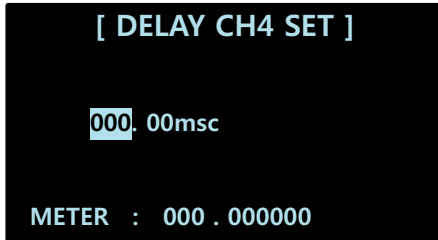

In DELAY settings, you can set the DELAY value for each channel. You can set values between 0.00 and 340.00msc in 48 Steps for each channel. Specifically, you can set the value you want down to the second decimal point. The initial value is set to 0.00msc.

If you set the DELAY value, the approximate value of the corresponding distance is displayed at the bottom in METER units.

※ The DELAY range you can set in the OUT MENU is between 0.00 and 100.00msc.

4. 4 PEQ SETTING

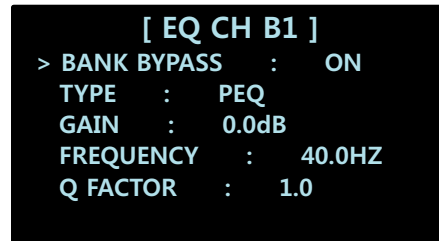
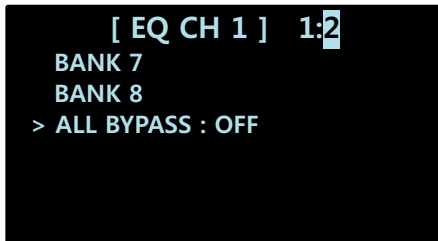
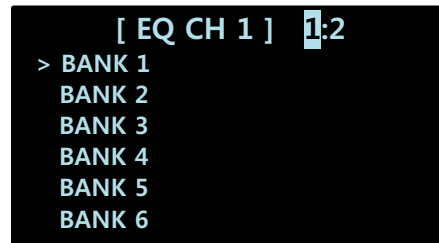
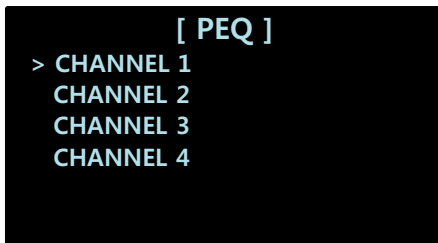

In PEQ settings, you can set up each channel differently.

Specifically, you can configure 8 BANKS from BANK 1 to 8 for each channel.

As for BANK BYPASS, you can select between ON and OFF. If BYPASS is set to ON, the device does not use the BANK value that has been set. If BYPASS is set to OFF, the device uses the BANK value that has been set.

For TYPE, you can select between PEQ, HSF, and LSF.

GAIN can be set between -15dB and +15dB in 0.1dB Step increments. Please be aware that increasing GAIN by too much may produce Residual Noise.

FREQUENCY can be set between 20Hz and 20kHz in 0.1Hz Step increments. The initial frequency setting values are 40Hz, 100Hz, 200Hz, 400Hz, 1kHz, 2kHz, 4kHz, 10kHz.

When TYPE is configured to PEQ, Q FACTOR can be set between 0.1 and 12.0 in 0.1 Step increments.

When TYPE is configured to HSF or LSF, it can be set between 0.1 and 1.0 in 0.1 Step increments.

4. 5 PRESET SETTING

```

[ PRESET ]
> LOAD PRESET
  SAVE PRESET
  PRESET LIST
  
```

```

[ PRESET NAME SET]
DSA_500Q_001!
  
```

PRESET settings offers Load preset, Save preset, and Preset list functions.

Load preset is a feature that imports a present you have saved previously. You cannot load any presents if you have never saved a preset before. From the loaded items, item 11 contains values set initially. You cannot modify item 11.

Save preset is a feature that allows you to save the preset you have configured so far. You can save up to a total of 10 presets. If you turn the SELECT/ENTER (ENCODER) dial at the front left/right, you can set the file name. If you press down the SELECT/ENTER (ENCODER) dial, you can move on to the next letter. You can type up to 16 characters.

In Preset list, you can check the items you have saved using Save preset. You can also change the name of the present in Preset list by turning the SELECT/ENTER (ENCODER) dial at the front of the device.

5. OUT MENU

5. 1 FILTER/X-OVER SETTING

```

[ FILTER.X-OVER ]
> CHANNEL 1
  CHANNEL 2
  CHANNEL 3
  CHANNEL 4
  
```

```

[ FILTER.XOVER CH1 ]
> FILTER   :   HPF
  FREQUENCY :   20.0HZ
  TYPE     :   OFF
  SLOPE    :   12dB
  
```

In FILTER/X-OVER settings, you can set up each channel differently.

As for FILTER, you can choose between HPF and LPF.

FREQUENCY can be set between 20Hz and 20kHz in 0.1Hz Step increments.

For TYPE, you can select between OFF, BUTTERWORTH, BESSEL, and LINKWITZ-RILEY.

SLOPE can be configured between 12dB/oct, 18dB/oct, and 24dB/oct.

5. 2 PEQ SETTING

```

[ PEQ ]
> CHANNEL 1
  CHANNEL 2
  CHANNEL 3
  CHANNEL 4

```

```

[ EQ CH 1 ] 1:2
> BANK 1
  BANK 2
  BANK 3
  BANK 4
  BANK 5
  BANK 6

```

```

[ EQ CH 1 ] 1:2
BANK 7
BANK 8
> ALL BYPASS : OFF

```

```

[ EQ CH B1 ]
> BANK BYPASS : ON
  TYPE : PEQ
  GAIN : 0.0dB
  FREQUENCY : 40.0HZ
  Q FACTOR : 1.0

```

In PEQ settings, you can set up each channel differently.

Specifically, you can configure 8 BANKS from BANK 1 to 8 for each channel.

Other instructions for PEQ is identical with the instructions for PEQ settings from the IN MENU.

For more detailed setting instructions, please refer to section 4. 4 PEQ SETTING on page 16 of this manual.

5. 3 LIMITER SETTING

```

[ LIMITER ]
> CHANNEL 1
  CHANNEL 2
  CHANNEL 3
  CHANNEL 4

```

```

[ LIMITER CH1 ]
> LIMITER : ON
  RELEASE : 20msec
  ATTACK : 1msec
  THRESHOLD :
    0.0dBfs

```

In LIMITER settings, you can set up each channel differently.

As for the LIMITER, you can select between ON and OFF. If the LIMITER is set to ON, the system will display a sub-menu where you can configure RELEASE, ATTACK, and THRESHOLD.

RELEASE can be set between 20msec and 4000msec in 1msec Step increments.

ATTACK can be set between 1msec and 50msec in 1msec Step increments.

THRESHOLD can be set between 0.0dBfs and 25dBfs in 0.1dBfs Step increments.

5. 4 POLARITY SETTING

```
[ POLARITY ]
> CH1  NORMAL
  CH2  NORMAL
  CH3  NORMAL
  CH4  NORMAL
```

In POLARITY settings, you can set up each channel differently.

You can configure each channel to NORMAL (normal phase) and INVERT (inverted phase), If you select INVERT, the phase will be inverted 180°. Initially, all channels are set to NORMAL.

5. 5 DELAY SETTING

```
[ DELAY CH4 SET ]

000.00msc

METER : 000 . 000000
```

In DELAY settings, you can set the DELAY value for each channel.

You can set values between 0.00 and 100.00msc in 48 Steps for each channel. Specifically, you can set the value you want down to the second decimal point.

The initial value is set to 0.00msc.

If you set the DELAY value, the approximate value of the corresponding distance is displayed at the bottom in METER units.

※ The DELAY range you can set in the IN MENU is between 0.00 and 340.00msc.

5. 6 PRESET SETTING

```
[ PRESET ]
> LOAD PRESET
  SAVE PRESET
  PRESET LIST
```

```
[ PRESET NAME SET]

DSA_500Q_001!!
```

PRESET settings offers Load preset, Save preset, and Preset List functions. Instructions for PRESET settings are identical to the instructions for PRESET settings from the IN MENU. For more detailed setting instructions, please refer to section 4. 5 PRESET SETTING on page 17 of this manual.

6. UTILITY SETTING

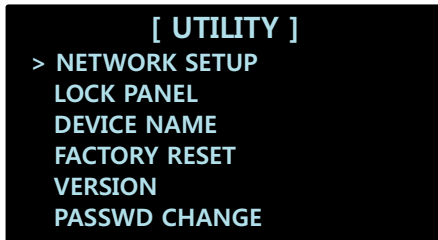

UTILITY SETTING features NETWORK SETUP, LOCK PANEL, DEVICE NAME, FACTORY RESET, VERSION, and PASSWD CHANGE.

6. 1 NETWORK SETUP



In NETWORK SETUP, you can check the NETWORK specifications of the current device.

For STATIC/DHCP, you can select the device's IP between STATIC (static IP) and DHCP (dynamic IP). Initially, the device is set to STATIC.

IP displays the IP address of the current device. Initially, the device is set to 192.168.1.99.

SUB displays the SUBNET MASK address of the current device. Initially, the device is set to 255.255.255.0.

GATE displays the GATE WAY address of the current device. Initially, the device is set to 192.168.1.1.

MAC displays the unique address of the current device. You cannot modify the MAC value.

CHANGE allows you to modify configuration values. Once you have changed the NETWORK SETUP configuration, set the selector to CHANGE and press down the SELECT/ENTER (ENCODER) dial at the front to save your new settings.

6. 2 LOCK PANEL

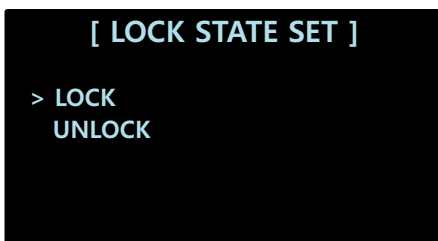

In LOCK PANEL, you can LOCK or UNLOCK the functions controlled from the front of the device.

If you set the device to LOCK, the system will redirect you to the initial OLED screen, and you will not be able to use the buttons at the front of the device. To UNLOCK the device, press down the SELECT/ENTER (ENCODER) dial at the front, then type the LOCK/UNLOCK password. The initial password is 0000.

※ In LOCK mode, when connecting a PC program, PC program will ask for the password of the device. Refer to the PC program manual for details.

6. 3 DEVICE NAME

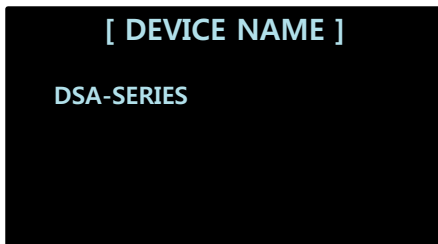

DEVICE NAME displays the name of the device. You can change the DEVICE NAME from the PC program. Please refer to the PC program manual for detailed instructions. You can download the PC program manual from our company's official website (www.inter-m.net).

6. 4 FACTORY RESET

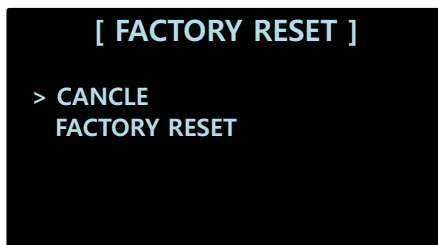

In FACTORY RESET, you can initialize the device to its factory settings.

If you press CANCEL or the ESC button at the front of the device, you will be redirected to the previous screen.

6. 5 VERSION

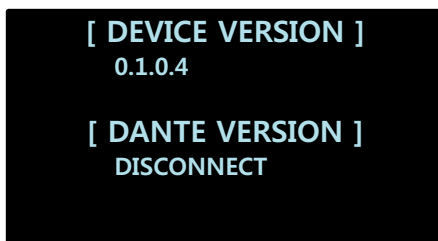

In VERSION, you can check the firmware version, DANTE NETWORK version of the current device.

The screen will display the firmware version of the device at all times. However, it will display the DANTE NETWORK version only when DANTE is connected to the device.

6. 6 PASSWD CHANGE

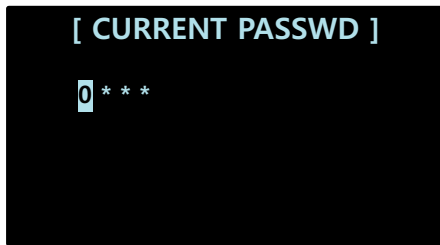

In PASSWD CHANGE, you can configure the password for the current device. You can select 4 numbers from 0 to 9. Turn the SELECT/ENTER (ENCODER) dial at the front of the device left/right to select the number you want. Once you have changed the password, press down the SELECT/ENTER (ENCODER) dial at the front to save your new password.

※ If you cannot remember your password, you can reset the device to factory settings using the FACTORY RESET option. Please be aware that FACTORY RESET will initialize all settings.

Applications

1. How to connect with your PC

- How to connect your PC with 1 device

Connect the ETHERNET PORT on the back of the device and the ETHERNET PORT on your PC.

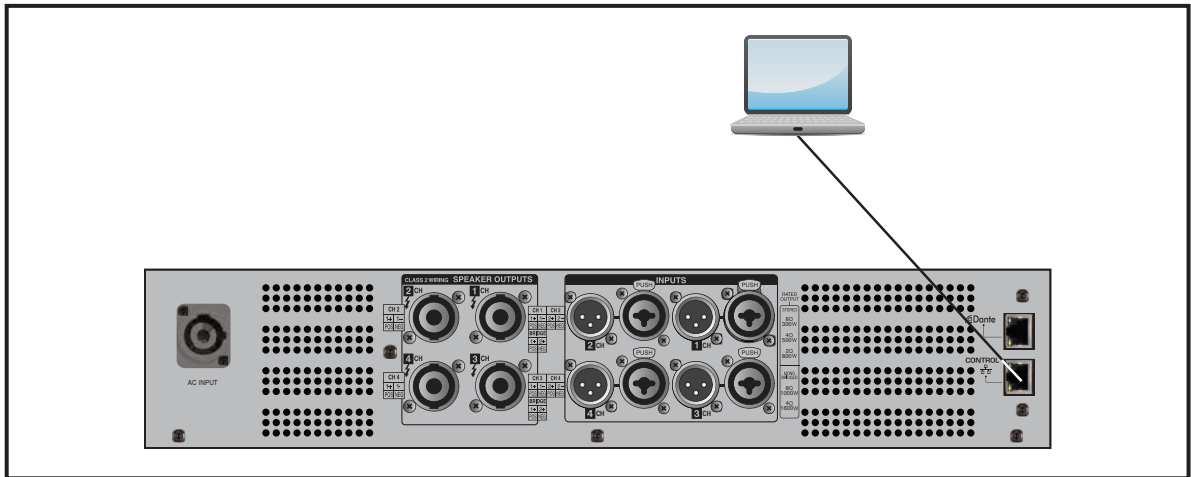

- How to connect your PC with 2 or more devices

Connect the ETHERNET PORT on the back of the device and the ETHERNET PORT on your PC using a HUB.

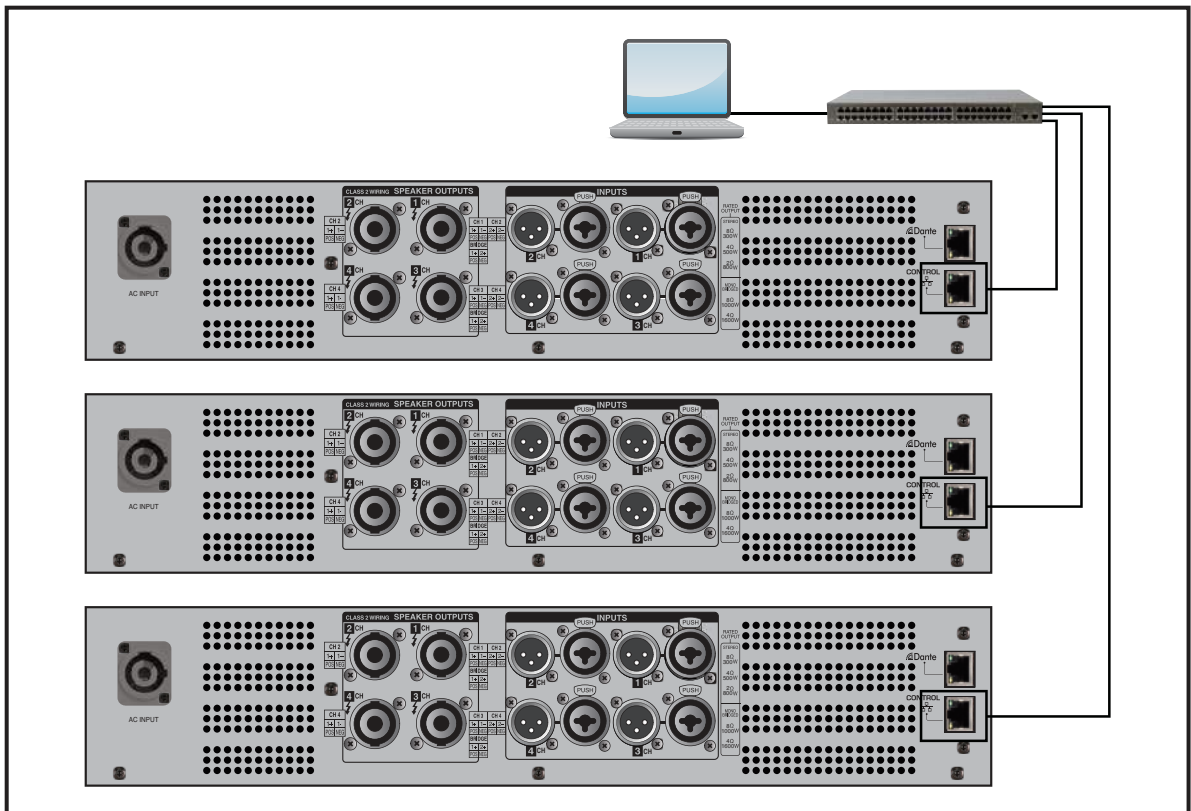

2. How to connect with a speaker/analog

- How to connect a PE15 with BRIDGED MODE (DSA-500Q)

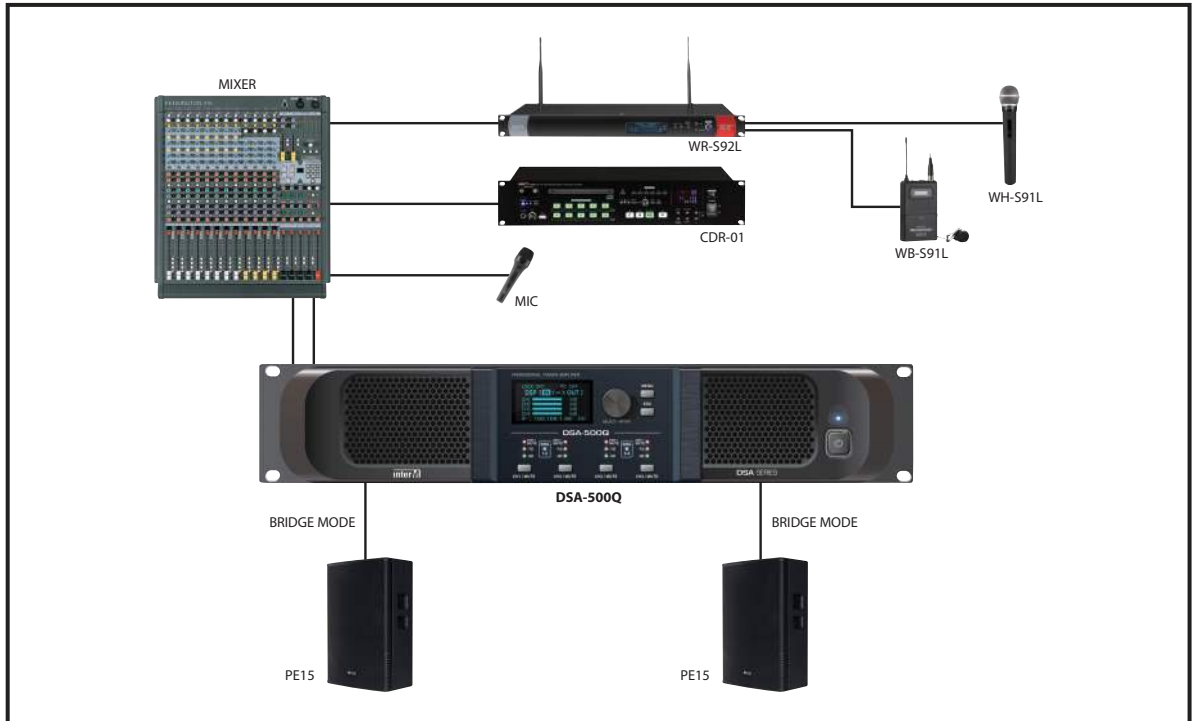

- How to connect an HE10 and HE15 with BRIDGED MODE (DSA-500Q)

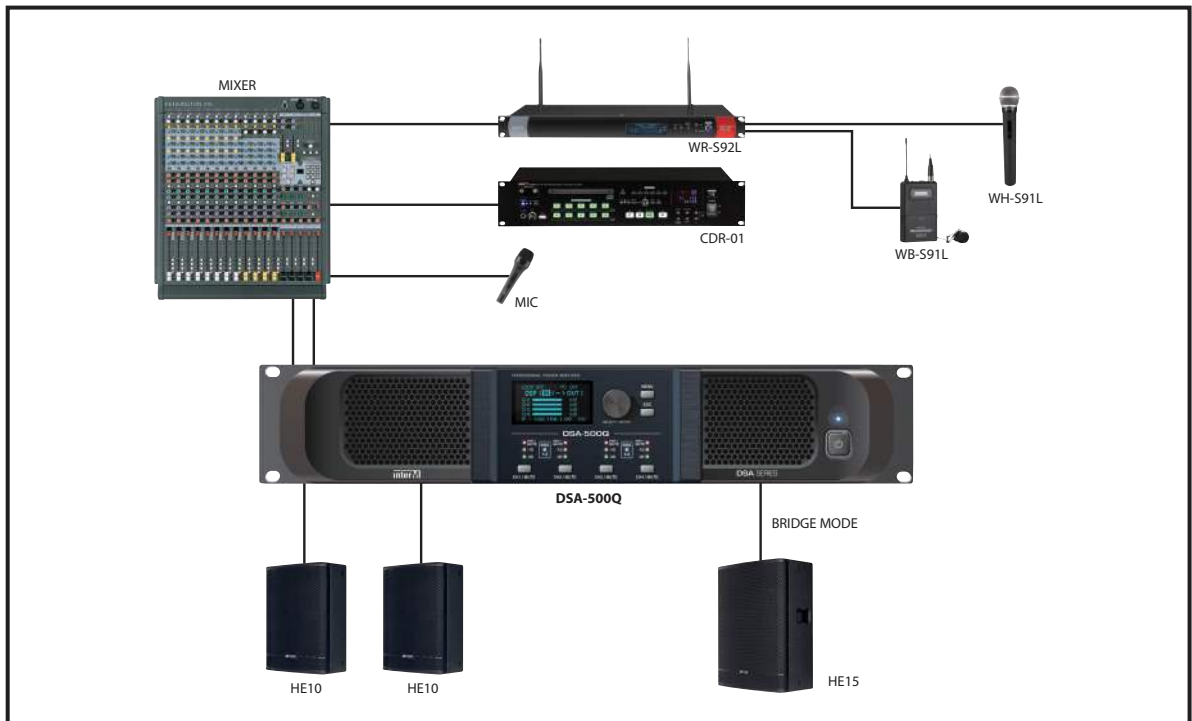

- How to connect an NLA-5/15S with BRIDGED MODE (DSA-2000Q)

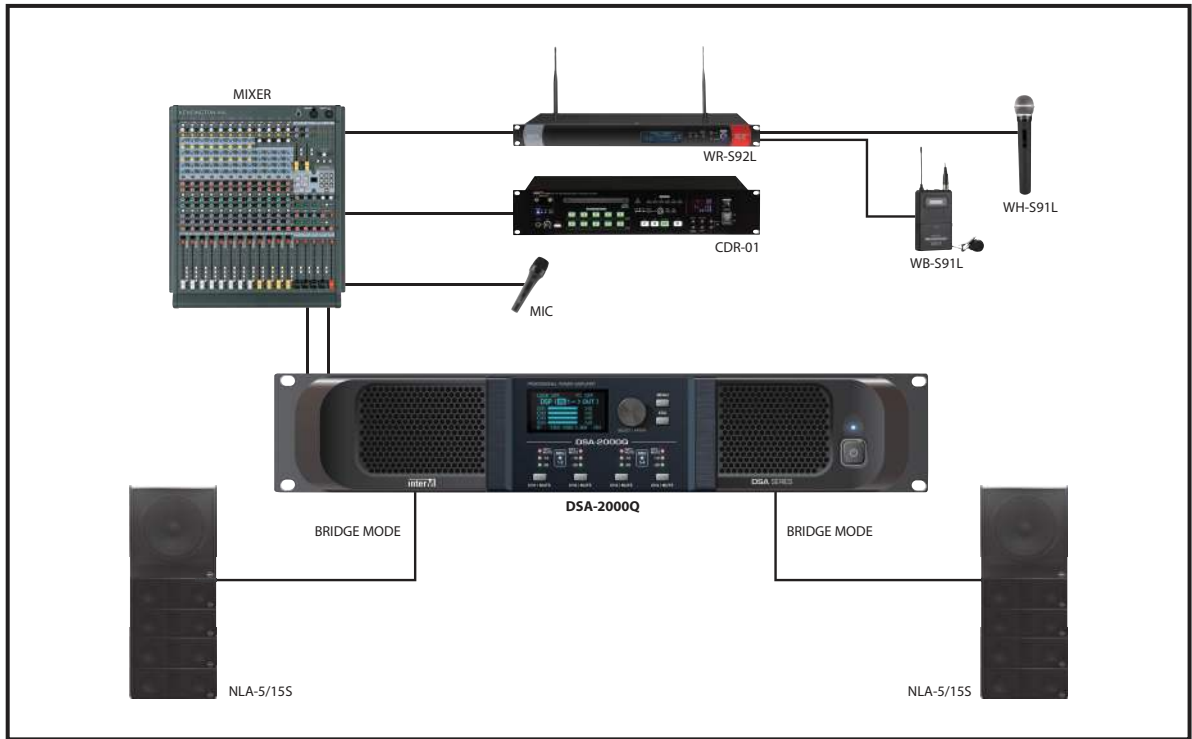

- How to connect a PE12 and NLA-5/15S with BRIDGED MODE

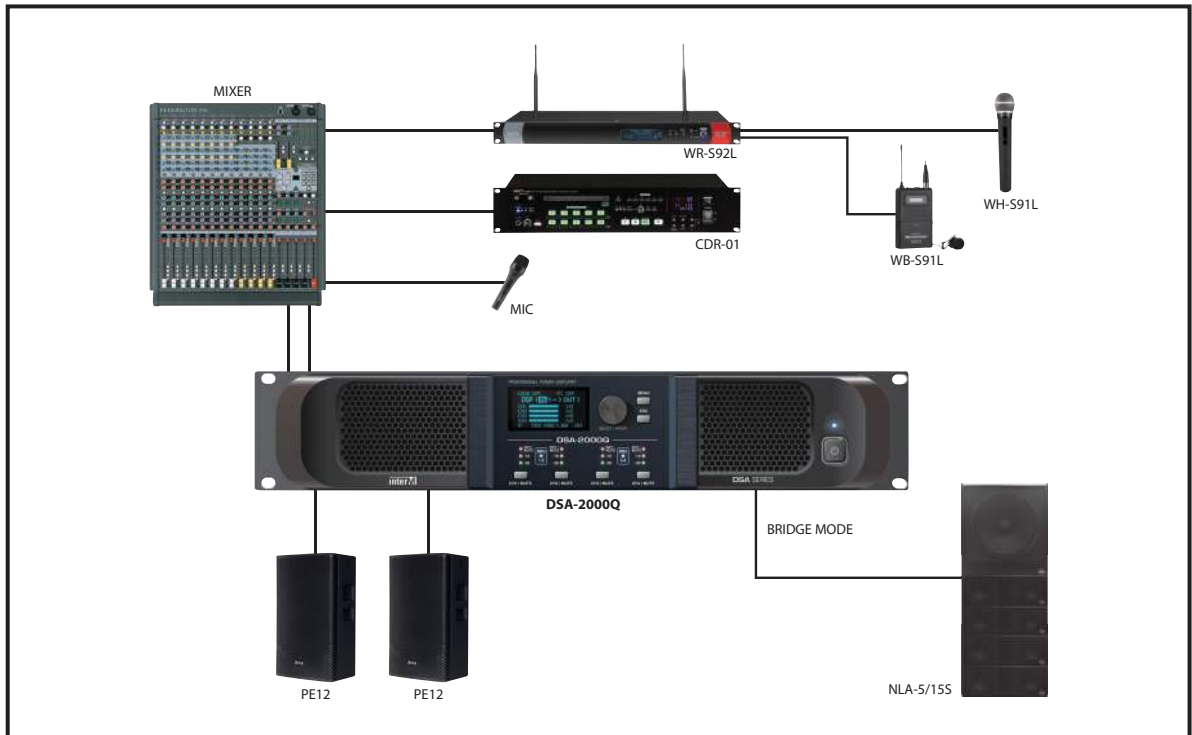

3. How to connect with speaker/network audio input

- How to connect a PE15 with BRIDGED MODE

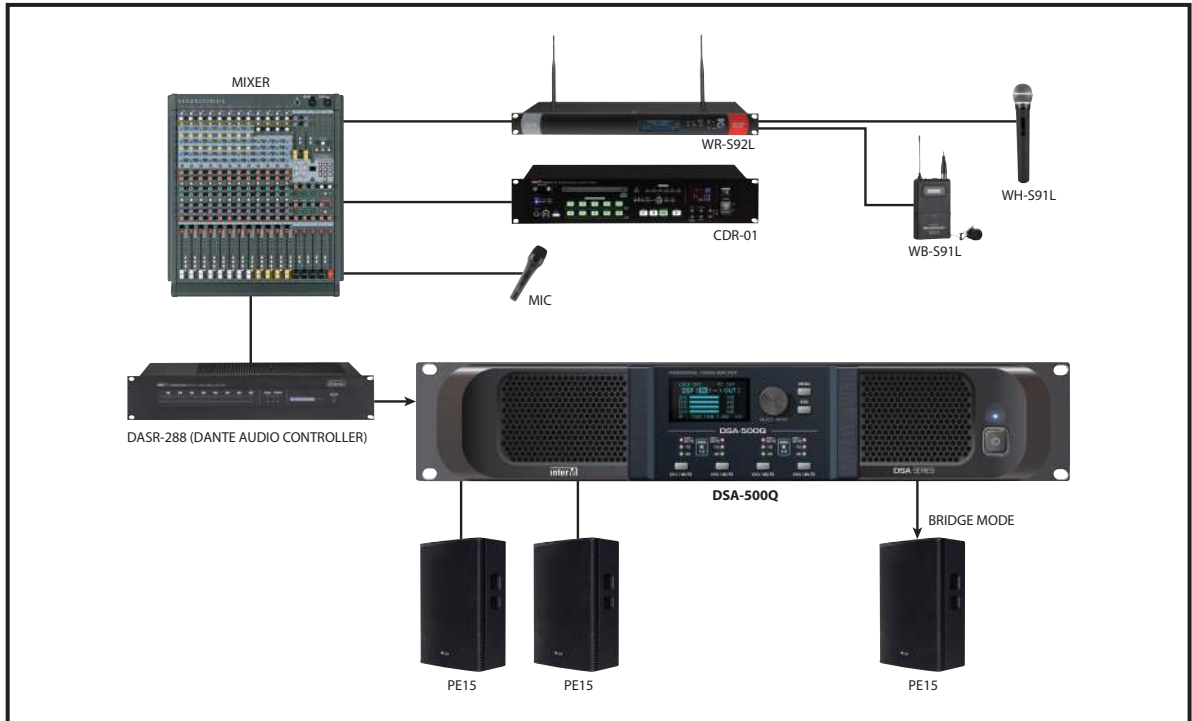

- How to connect an HE10 and HE15 with BRIDGED MODE

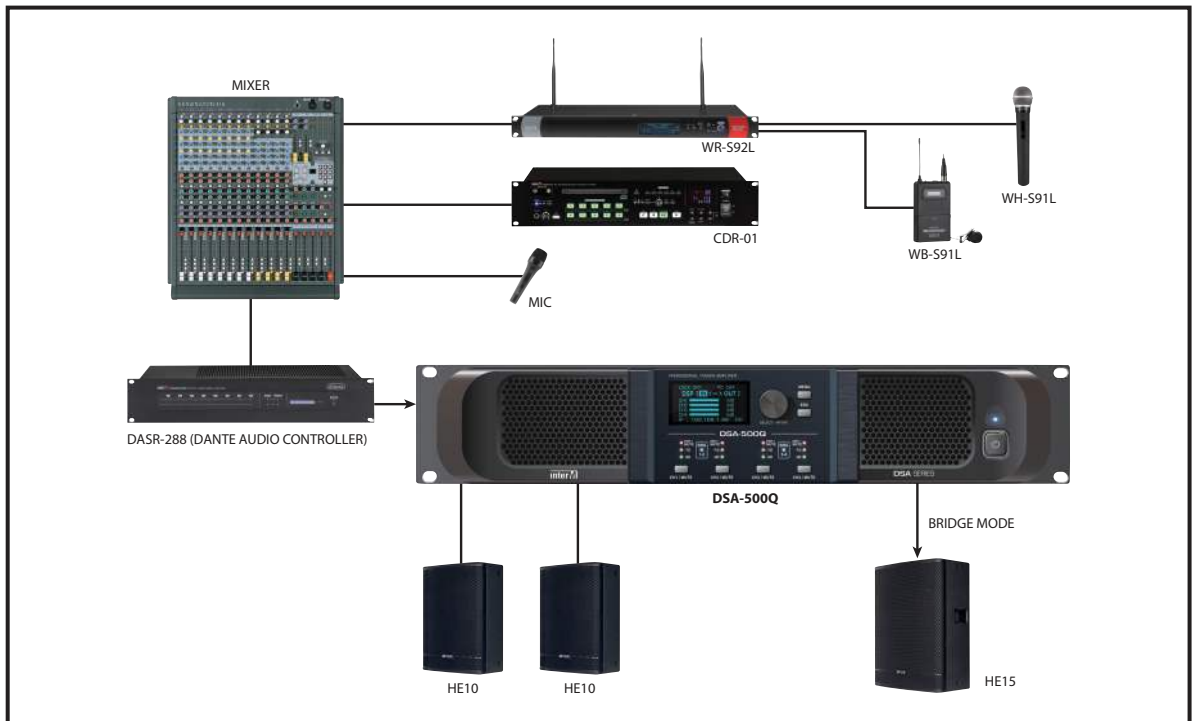

Block Diagram

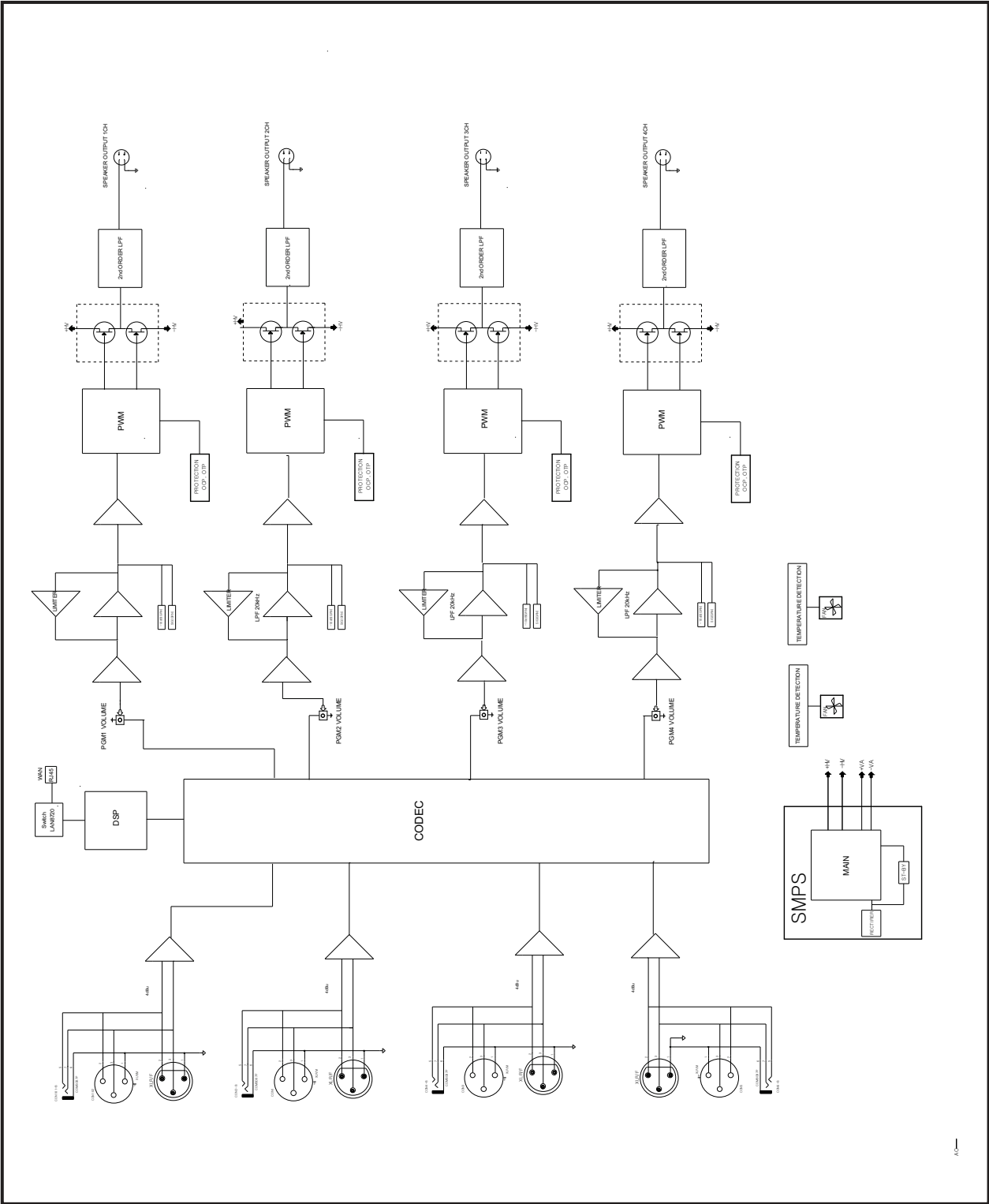

Specifications

		DSA-500Q	DSA-2000Q
Rated Output power -20ms burst	8Ω, STEREO MODE	300W	1200W
	4Ω, STEREO MODE	500W	2000W
	2Ω, STEREO MODE	800W	2000W
	8Ω, BRIDGED MONO MODE	1000W	4000W
	4Ω, BRIDGED MONO MODE	1600W	4000W
Input Sensitivity		+4dBu	+10dBu
GAIN(STEREO,MONO)		32dB	
GAIN(BRIDGE)		38dB	
S/N		Better than 92dB	
THD	1/3W Rated power	Less than 0.5%	Less than 0.7%
Frequency Response (1W, 0±2dB / 8Ω)		20Hz~20kHz	
DSP Performance		32bit Fixed Point(8.24 format)	
A/D, D/A Performance		24bit conversion, sampling rate : 48kHz	
DSP Function		input gain, Parametric EQ, HPF, LPF, Limiter, Delay	
Operating Temperature/Humidity		-10℃~+40℃ / 0%~90%	
Power Source		AC 220-240V, 50/60Hz	
Power Consumption (1/8 rated output power@2Ω)		390W	700W
Weight (Set)		10.48Kg	11.79Kg
Dimensions (Set)		482(W) x 88(H) x 420(D)mm	

* Design and specification are subject to be changed for the improvement of product quality without pre notice.

※ DIMENSIONS

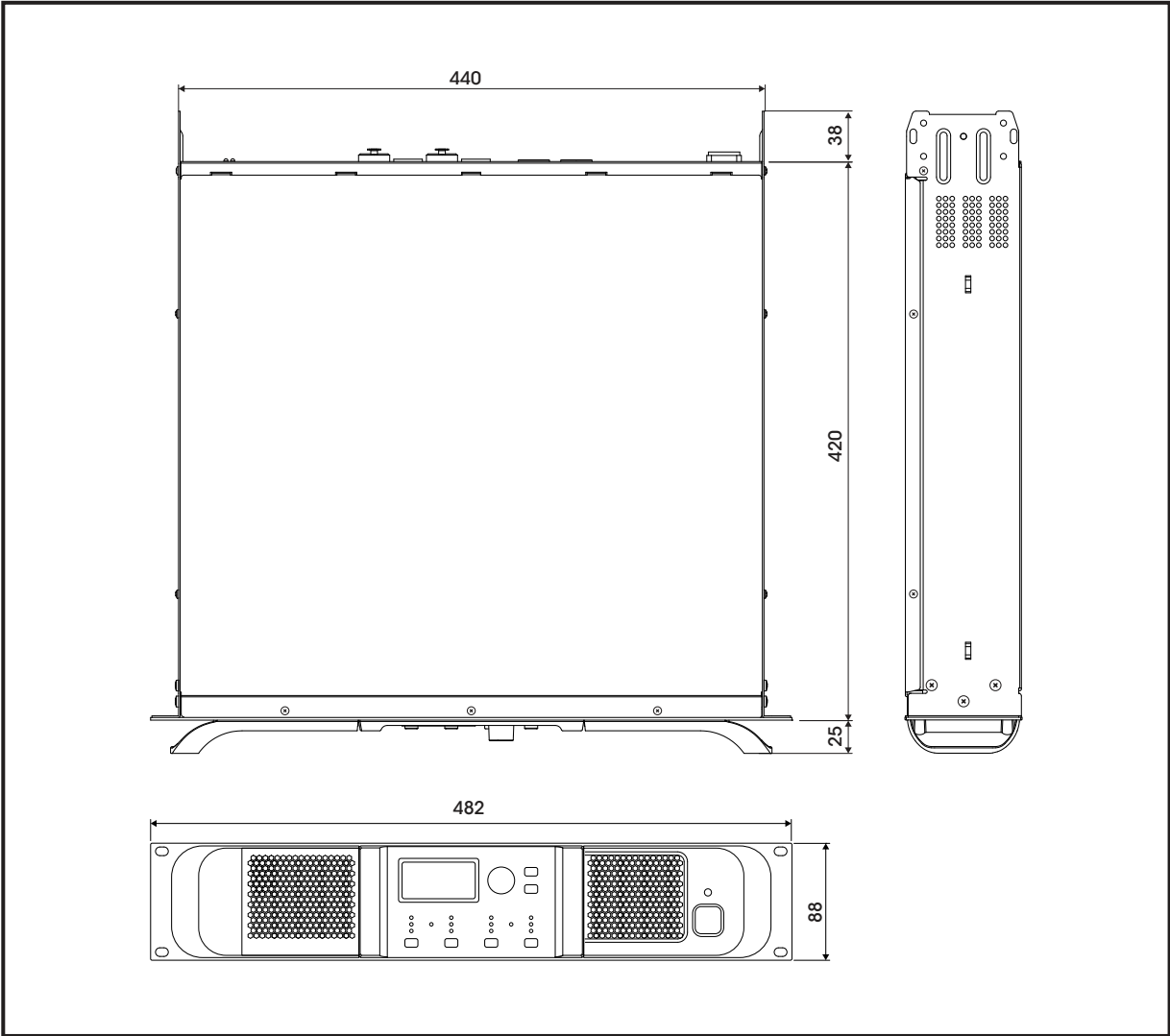

Service

Procedures

Take steps to insure the problem is not related to operator error or other products within the system. Information provided in the troubleshooting portion of this manual may help with this process. Once it is certain that the problem is related to the product contact your warranty provider as described in the warranty section of this manual.

Schematic

A Schematic is available by contacting your warranty provider.

Parts List

A Parts List is available by contacting your warranty provider.

Variations and Options

Variations

Products supplied through legitimate sources are compatible with local AC power requirements.

Options

No optional items are available for this product.

Warranty

Warranty terms and conditions vary by country and may not be the same for all products. Terms and conditions of warranty for a given product may be determined first by locating the appropriate country which the product was purchased in, then by locating the product type.

To obtain specific warranty information and available service locations contact Inter-M directly or the authorized Inter-M Distributor for your specific country or region.



Inter-M, Ltd. (Korea) began operations in 1983.

Since then, Inter-M has grown to become one of the largest manufacturers of professional audio and commercial sound electronics equipment in the world.

Inter-M has gained worldwide recognition for its own branded products, as well as private label manufacturing of electronics sold under other names (OEM).

The company is no longer just a Korean company, but rather a global company that is truly international in scope, with factories and offices in Korea and China, and sales and marketing operations located in Japan, Europe, and the U.S.A.

With more than 850 employees around the globe, Inter-M is well-poised for further growth and expansion.

Inter-M Americas, INC.

5666 CORPORATE AVE. CYPRESS, CA 90630
TEL : +1-714-828-2200, FAX : +1-714-828-2210
Home Page : <http://www.inter-m.net>, E-mail : info@inter-m.net

Inter-M Corporation

SEOUL OFFICE : 719, DOBONG-RO, DOBONG-GU, SEOUL, KOREA
TEL : +82-2-2289-8140~8, FAX : +82-2-2289-8149
Home Page : <http://www.inter-m.com>, E-mail : overseas@inter-m.com

MADE IN KOREA
January 2020 147174