

Operation Manual

AMP Fault Detector **AFD-6218**



*Rack mount products in the Western Hemisphere (North America, South America, and the Caribbean) do not have handles installed due to customer preference.

interM

Welcome

A personal welcome to you from the management and employees of Inter-M

All of the co-workers here at Inter-M are dedicated to providing excellent products with inherently good value, and we are delighted you have purchased one of our products.

We sincerely trust this product will provide years of satisfactory service, but if anything is not to your complete satisfaction, we will endeavor to make things right.

Welcome to Inter-M, and thank you for becoming part of our worldwide extended family!

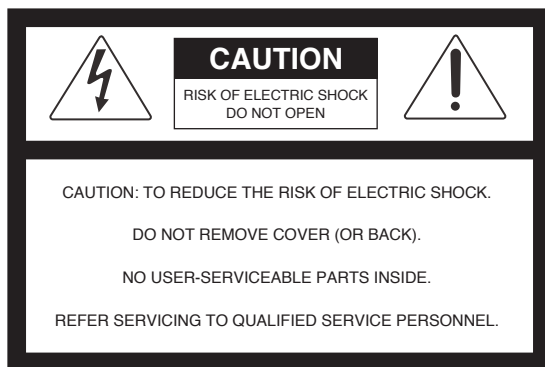

WARNING

To prevent fire or shock hazard, do not expose the unit to rain or moisture.

*WARNING FOR YOUR PROTECTION PLEASE READ THE FOLLOWING-WATER AND MOISTURE: Unit should not be used near water(e.g. near a bathtub, washbowl, kitchen sink, laundry tub, in a wet basement, or near a swimming pool, etc). Care should be taken so than objects do not fall and liquids are not spilled into the enclosure through openings.

*CLASS 2 WIRING (Adjacent to speaker terminal): The speaker output of this apparatus can exceed 10 Watts and could be a shock injury. Connection to speakers should be performed by a skilled person.

*Do not install this equipment in a confined space such as a book case or similar unit.

*This apparatus shall not be exposed to dripping or splashing and no objects filled with liquids, such vases, shall be placed on the apparatus.

*This apparatus shall be connected to a mains socket outlet with a protective earthing connection.

*It has need to be easy to disconnect the device. To disconnect the device from power, separate AC input cable from inlet or unplug the AC Cord.

CAUTION

*These servicing instructions are for use by qualified service personnel only. To reduce the risk of electric shock, do not perform any servicing other than that contained in the operating instructions unless you are qualified to do so.

NOTE

*This equipment has been tested and found to comply with the limits for a Class A digital device, pursuant to Part 15 of the FCC Rules. These limits are designed to provide reasonable protection against harmful interference when the equipment is operated in a commercial environment. This equipment generates, uses, and can radiate radio frequency energy and, if not installed and used in accordance with the instruction manual, may cause harmful interference to radio communications. Operation of this equipment in a residential area is likely to cause harmful interference in which case the user will be required to correct the interference at his own expense.



This symbol is intended to alert the user to the presence of uninsulated "dangerous voltage" within the product's enclosure that may be of sufficient magnitude to constitute a risk of electric shock to persons.



This symbol is intended to alert the user to the presence of important operation and maintenance (servicing) instructions in the literature accompanying the appliance.

Caution: To prevent electric shock do not use this (polarized) plug with an extension cord, receptacle or other outlet unless the blades can be fully inserted to prevent blade exposure.

Attention: Pour prévenir les chocs électriques ne pas utiliser cette fiche polarisée avec un prolongateur, une prise de courant on une autre sortie de courant, sauf si les lames peuvent être insérées à fond sans en laisser aucune partie à découvert.

Contents

Unpacking	2
Installation	
Environment	2
Important Safety Instructions	2
Features	3
Equipment Setting and Checking	4
Operation Method	5
Front Panel	6
Rear Panel	7
Applications	9
Block Diagram	10
Specifications	11
Service	13
Warranty	13

Unpacking

Although your AFD-6218 is neither complicated nor difficult to operate, we recommend you take a few minutes to read this brief manual and familiarize yourself with the important information regarding product features, setup and operation.

As with most electronic devices, we strongly recommend you to retain the original packaging. In the unlikely event the product must be returned for servicing, the original packaging (or reasonable equivalent) is required.

Installation

Environment

Never place this product in an environment which could alter its performance or reduce its service life. Such environments usually include high levels of heat, dust, moisture, and vibration.

IMPORTANT SAFETY INSTRUCTIONS

1. Read these instructions.
2. Keep these instructions.
3. Heed all warnings.
4. Follow all instructions.
5. Do not use this apparatus near water.
6. Clean only with dry cloth.
7. Do not block any ventilation openings. Install in accordance with the manufacturer's instructions.
8. Do not install near any heat sources such as radiators, heat registers, stoves, or other apparatus (including amplifiers) that produce heat.
9. Do not defeat the safety purpose of the polarized or grounding-type plug. A polarized plug has two blades with one wider than the other. A grounding type plug has two blades and a third grounding prong. The wide blade or the third prong are provided for your safety. If the provided plug does not fit into your outlet, consult an electrician for replacement of the obsolete outlet.
10. Protect the power cord from being walked on or pinched particularly at plugs, convenience receptacles, and the point where they exit from the apparatus.
11. Only use attachments/accessories specified by the manufacturer.
12. Use only with the cart, stand, tripod, bracket, or table specified by the manufacturer, or sold with the apparatus. When a cart is used, use caution when moving the cart/apparatus combination to avoid injury from tip-over.
13. Unplug this apparatus during lightning storms or when unused for long periods of time.
14. Refer all servicing to qualified service personnel. Servicing is required when the apparatus has been damaged in any way, such as power-supply cord or plug is damaged, liquid has been spilled or objects have fallen into the apparatus, the apparatus has been exposed to rain or moisture, does not operate normally, or has been dropped.



Features

- **Automatic Check**
Check the status of amp connected to each channel automatically according to the time-set.
- **Display Amp Status**
Display the status of amp connected to each channel by LED
- **Automatic Change**
Channel which fault occurs when checking out the amp will be switched to spare amp automatically.
- **Check Time setup**
You can set up 5 different time intervals for automatic self check.

Equipment Setting and Checking

1. ADDRESS SETTING

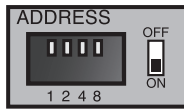

- Set the equipment numbers for each deciding condition using the rear panel DIP switch.
- If the equipment number is not set-up or is incorrect, all Zone Indicator LEDs will blink.
- If the number is already in-use, the system will not function properly.
- Please check the equipment number set-up status.

Setting should be as below table, and if data number is added to switch which is On, it will be the equipment number.

Pin No.	1	2	3	4	5	
Data	1	2	4	8	16	
Address	1	ON				
	2		ON			
	3	ON	ON			
	4			ON		
	5	ON		ON		
	:	:	:	:	:	
	15	ON	ON	ON	ON	
	16					ON
	:	:	:	:	:	

(Ex: when number 1 and 3 is ON, 1 and 4 is added, so equipment number will be 5.)

2. TERMINATION SWITCH (LOAD/OPEN) SETTING

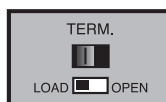

- 1) For the system linked by using RS-485 communication interface, it is necessary to set the termination switch (LOAD/OPEN) on the rear panel to stabilize data transfer.
- 2) Set the termination switch to LOAD only for the first and last-numbered equipment units. All others must be set to OPEN.

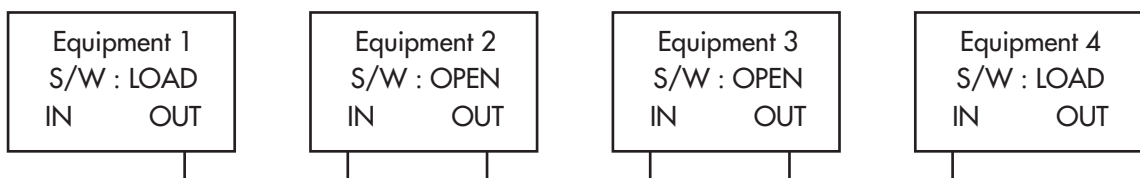

※CAUTION : Communication error may occur if setting is performed incorrectly.

Operation Method

1. Turn on the power, and then normal AMP status will be checked automatically after 10 seconds.
2. If one or more fault amp is detected, buzzer will be generated, and fault amp detected first will be replaced with spare amp
3. If Buzzer off button pushed which located on front panel, it will not be generate.
4. LED which amp is in fault status will be red, and if it is replaced with spare, red LED will blink.
If two or more channels are fault, channel which has higher priority will be replaced with spare amp.
5. Check automatically according to checking times which has been set manually.
6. It will be automatically switched to normal amp if Test button of the channel is pushed after fault amp is restored to its original status.

Front Panel

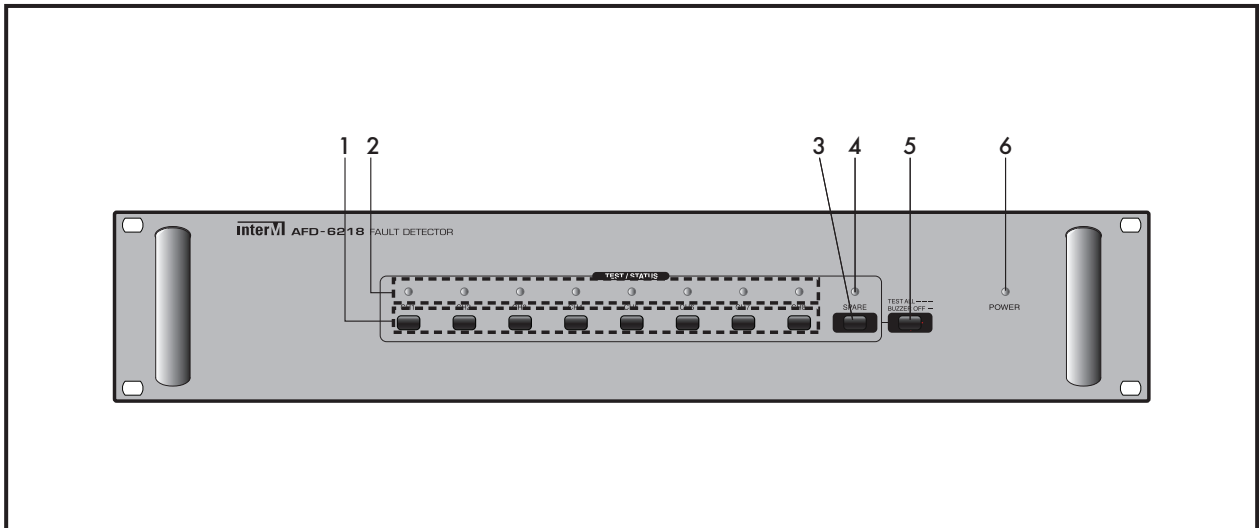

- 1. TEST BUTTON (NORMAL AMP)**
It is the button used when testing the amp in each channel manually.
- 2. STATUS LED (NORMAL AMP)**
It displays each amp's status.
GREEN : Normal
RED : Fault (LED will blink if the channel is replaced with spare.)
- 3. TEST BUTTON (SPARE AMP)**
It is the button used when testing the spare amp manually.
- 4. STATUS LED (SPARE AMP)**
It is the LED which displays the status of spare amp.
GREEN : Normal
RED : Fault
- 5. BUZZER OFF / TEST ALL BUTTON**
When this button is pressed in a short time, buzzer will be off.
When this button is pressed in a long time, fault will be check (All channel).
- 6. POWER LED**
It will be on if power is supplied.

Rear Panel

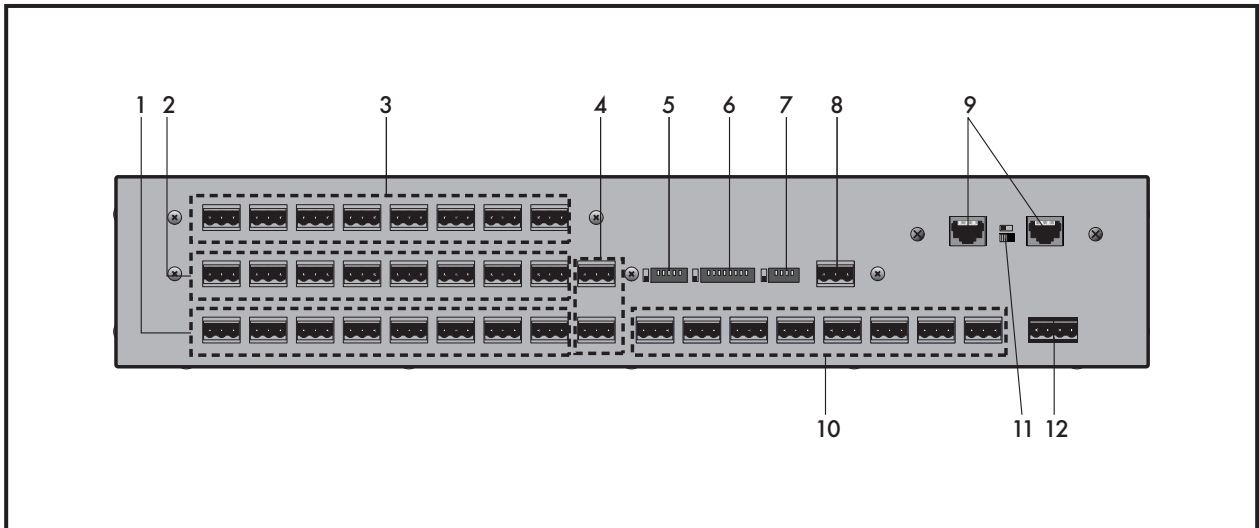

1. FROM AMP TERMINAL

It is the terminal connecting to outputs of each amp.
Amp status will be checked through signals coming to this terminal.

2. TO AMP TERMINAL

It is the terminal connecting to inputs of each amp.
It delivers the signal received from free amp to each amp input.

3. AUDIO INPUT TERMINAL

It is the terminal connecting to output of free amp.

4. BACK-UP IN/OUT TERMINAL

It is the terminal connecting the spare amp which is used in case of emergency.
Input of spare amp is connected to Back-Up In terminal, and output to Back-Up Out. This spare amp should have same or equivalent output of amp used.

5. ADDRESS SWITCH

It is the switch which sets up the role of each system if device is expanded and interlocked.
For details of equipment setting, please refer to page 4

6. AMP SET SWITCH

It is the switch used when selecting the use of each channel. (CH1~CH8 = PIN1~PIN8)
Turn off the switch for the channel which will not be used.

7. CHECK TIME SET SWITCH

It is the switch used when selecting the time intervals for amp automatic checking.
One of five can be selected as shown in table.

PIN 1	PIN2	PIN3	PIN4	Interval
OFF	OFF	OFF	OFF	OFF
ON	OFF	OFF	OFF	1Min
OFF	ON	OFF	OFF	1HR
OFF	OFF	ON	OFF	6HR
OFF	OFF	OFF	ON	12HR
ON	ON	ON	ON	24HR

8. RELAY OUTPUT TERMINAL

It is the terminal used when operating other peripheral devices in case of amp failure.

- NO: Normal Open operation
- NC: Normal Close operation
(Normal means STANDBY)

Status of contact point output will be following. (Opposite operations for each other)

System Mode	RELAY OUTPUT	
	NO	NC
STANDBY	OPEN	CLOSE
AMP Fault	CLOSE	OPEN

9. LINK IN/OUT TERMINAL

It is the communication terminal to monitor the line check result from PC.

Link in is connected to the previous device, and Link out is connected to the next device.



Pin No.	Functions	Pin No.	Functions
1	RS-485 Data - A	5	GND
2	RS-485 Data - B	6	RS-485 Data - Y
3	RS-485 Data - Z	7	NA
4	NA	8	NA

※ Same for all IN/OUT terminals.

10. SPEAKER OUTPUT TERMINAL

It is the terminal which outputs of each amp will be output through AFD-6218.

11. TERMINATION SWITCH (LOAD/OPEN)

It is the switch which is set for stable data receiving/transmitting of link in/out.

For details of equipment setting, please refer to page 4

※CAUTION : communication error may occur if it is not set correctly.

12. POWER INPUT TERMINAL

It is the terminal which connects the DC power (DC 24V). Caution to polarities when it connects.

Applications

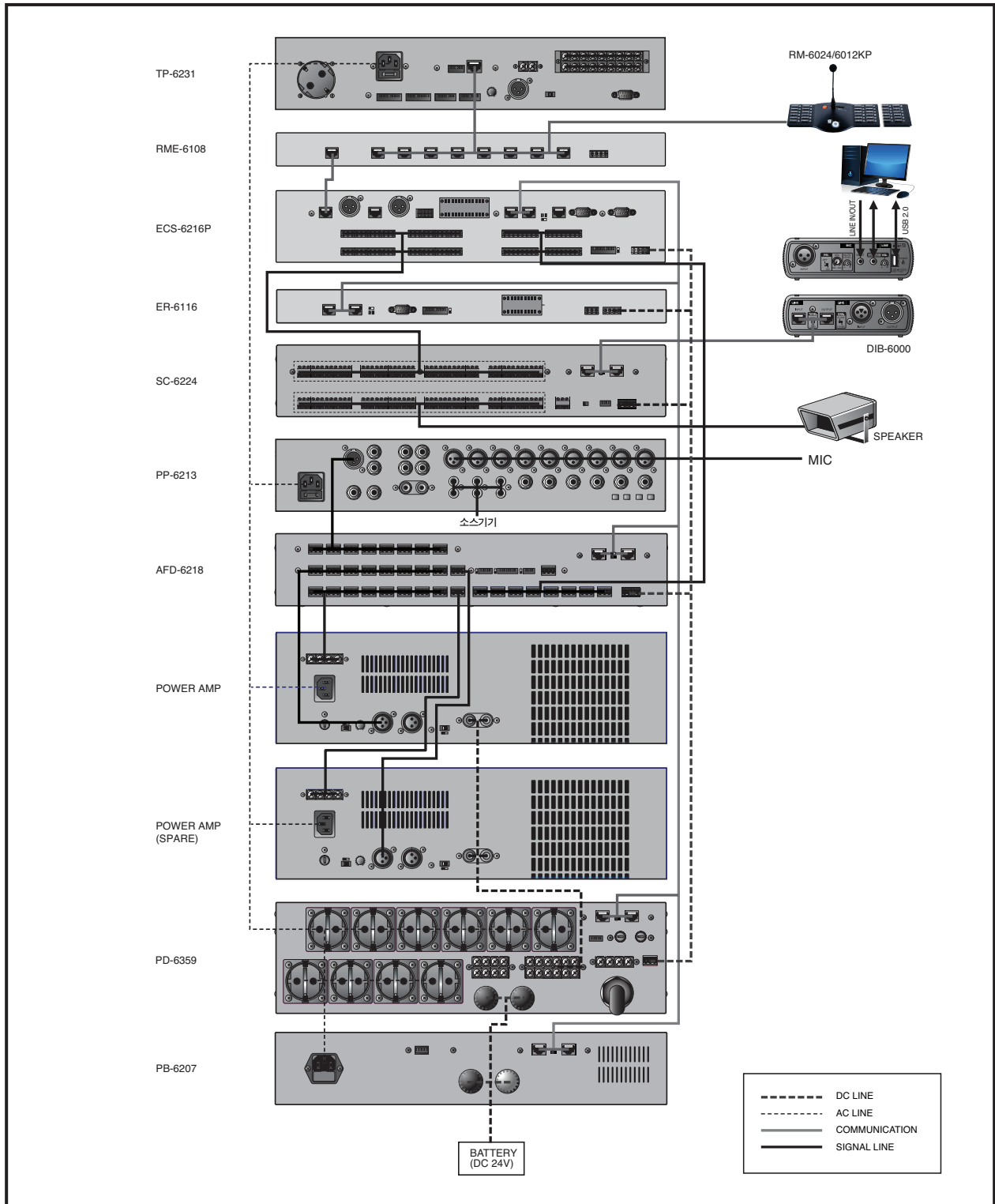

Block Diagram

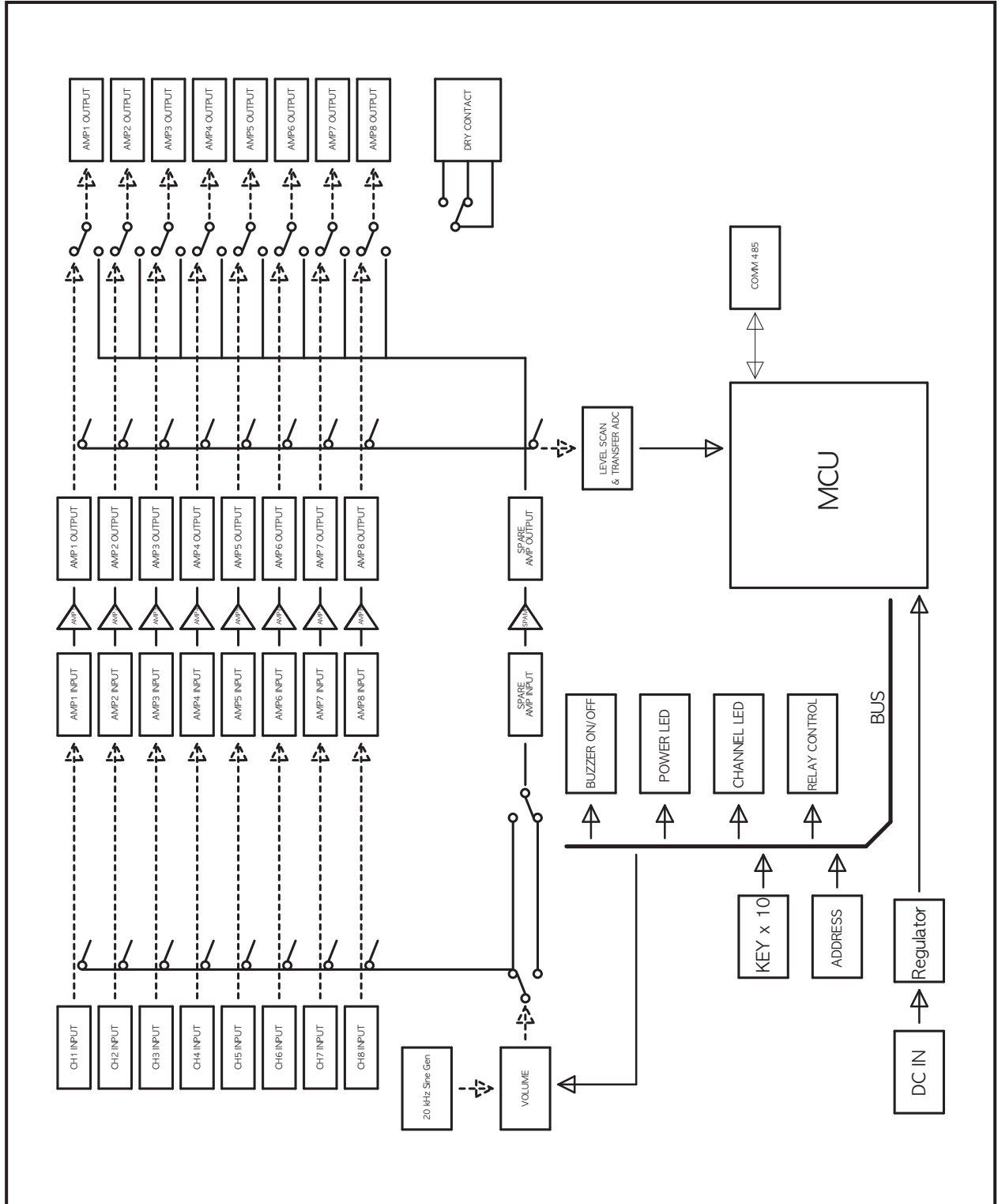

Specifications

	AFD-6218
Amp Input	9 Channels (Spare 1 Channel)
Amp Output	9 Channels (Spare 1 Channel)
Audio Input	8 Channels
Operation Temperature	-10°C ~ +40°C
Power Source	DC +24V, 170mA
Weight (SET)	4Kg/8.8lb
Dimensions (SET)	482(W)x88(H)x280(D)mm/19(W)x3.5(H)x11(D)in
Accessory	
LINK IN/OUT Cable	UTP Cable (500mm)

* Specifications and design subject to change without notice.

※ DIMENSIONS

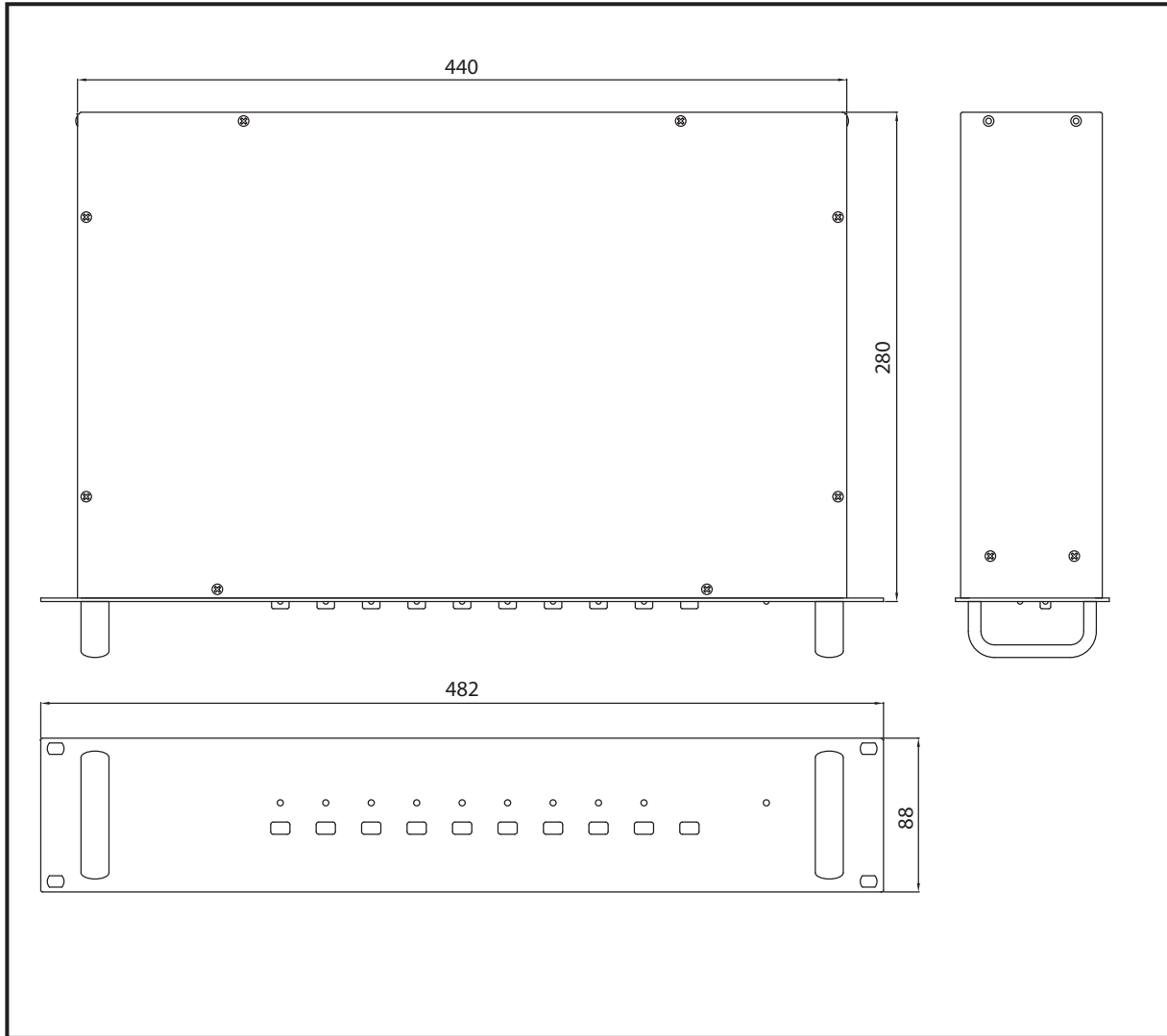

Service

Procedures

Take steps to insure the problem is not related to operator error or other products within the system. Information provided in the troubleshooting portion of this manual may help with this process. Once it is certain that the problem is related to the product contact your warranty provider as described in the warranty section of this manual.

Schematic

A Schematic is available by contacting your warranty provider.

Parts List

A Parts List is available by contacting your warranty provider.

Warranty

Warranty terms and conditions vary by country and may not be the same for all products. Terms and conditions of warranty for a given product may be determined first by locating the appropriate country which the product was purchased in, then by locating the product type.

To obtain specific warranty information and available service locations, contact Inter-M directly or the authorized Inter-M Distributor for your specific country or region.

interM



Inter-M, Ltd. (Korea) began operations in 1983.

Since then, Inter-M has grown to become one of the largest manufacturers of professional audio and commercial sound electronics equipment in the world.

Inter-M has gained worldwide recognition for its own branded products, as well as private label manufacturing of electronics sold under other names (OEM).

The company is no longer just a Korean company, but rather a global company that is truly international in scope, with factories and offices in Korea and China, and sales and marketing operations located in Japan, Europe, and the U.S.A.

With more than 850 employees around the globe, Inter-M is well-poised for further growth and expansion.

Inter-M Americas, Inc.

13875 Artesia Blvd. Cerritos, CA 90703 USA
TEL : +1-562-921-0313, FAX : +1-562-921-0370
Home Page : <http://www.inter-m.net>, E-mail : info@inter-m.net

Inter-M Corporation

Seoul OFFICE: 653-5 BANGHAK-DONG, DOBONG-KU, SEOUL, KOREA
TEL : +82-2-2289-8140~8, FAX : +82-2-2289-8149
Home Page : <http://www.inter-m.com>, E-mail : overseas@inter-m.com

MADE IN KOREA
June 2012